

HP 9000 Model 382
Owner's Guide
for HP-UX Users

HP 9000 Series 300 Workstation Controllers



HP Part No. A1473-90019
Printed in USA December 1992

Edition 2
E1292

Notices

Information in this document is subject to change without notice.

Hewlett-Packard makes no warranty of any kind about this manual, including, but not limited to, the implied warranties of merchantability and fitness for a particular purpose. Hewlett-Packard shall not be liable for errors contained herein or direct, indirect, special, incidental or consequential damages about the furnishing, performance, or use of this material.

Warranty. Please read the enclosed *Hewlett-Packard Software Product License Agreement and Limited Warranty* before operating this product. Rights in the software are offered only on the condition that the customer accepts all terms and conditions of the License Agreement.

Operating the product indicates your acceptance of these terms and conditions. If you do not agree to the License Agreement, you may return the unused product for a full refund.

A copy of the specific warranty terms applicable to your Hewlett-Packard product and replacement parts can be obtained from your local Sales and Service Office.

Copyright © 1992 Hewlett-Packard Company

This document contains information which has been protected by copyright. All rights are reserved. Reproduction, adaptation, or translation without prior written permission is prohibited, except as allowed under the copyright laws.

Copyright © AT&T, Inc. 1980, 1984, 1986

Copyright © The Regents of the University of California 1979, 1980, 1983, 1985.

This software and documentation is based in part on the Fourth Berkeley Software Distribution under license from the Regents of the University of California.

Restricted Rights Legend

Use, duplication or disclosure by the United States Government is subject to restrictions as set forth in subparagraph (c) (1) (ii) of the Rights in Technical Data and Computer Software clause at FARs 52.227.7013.

Hewlett-Packard Company
OSSD Learning Products
3404 East Harmony Road
Fort Collins, Colorado 80525

Printing History

New editions of this manual incorporate all material updated since the previous edition.

This manual's printing date and part number show its current edition. The printing date changes when a new edition is printed. Minor changes may be made at reprint without changing the printing date. The manual part number changes when extensive technical changes are incorporated.

December, 1992 Edition 2. This Edition includes material which appeared in the *Model 382 and R/382 Owner's Guide* (P/N A1473-90011) and the *Model 382 Owner's Guide* (P/N A1473-90014). New SAM, HP VUE, and device installation information has been added for HP-UX 9.0.

Safety Symbols and Conventions

The following conventions are used throughout this manual:

Note	Notes contain important information set apart from the text.
-------------	--

Caution	Caution messages indicate procedures which, if not observed, could result in loss of data or damage to equipment. Do not proceed beyond a CAUTION message unless you fully understand and have met the conditions stated therein.
----------------	---

Warning	Warning messages indicate procedures or practices which, if not observed, could result in personal injury. Do not proceed beyond a WARNING message unless you fully understand and have met the conditions stated therein.
----------------	---

Regulatory Information

■ FCC Statement (For U.S.A. Only)

The Federal Communications Commission (in Subpart J of Part 15, Docket 20780) has specified that the following notice be brought to the attention of the users of this product:

This equipment generates, uses, and can radiate radio frequency energy and if not installed and used in accordance with the instructions manual, may cause interference to radio communications. It has been tested and found to comply with the limits for a Class A computing device pursuant to Subpart J of Part 15 of FCC rules, which are designed to provide reasonable protection against such interference when operated in a commercial environment. Operation of this equipment in a residential area is likely to cause interference in which case the user at his own expense will be required to take whatever measures may be required to correct the interference.

■ Turvallisuusyhteenvedo (Finland Only)

Laserturvallisuus

Luokan 1 Laserlaite

Klass 1 Laser Apparat

HP 9000 Model 382 tietokoneeseen voidaan asentaa muistilaitteeksi laitteensisäinen CD-ROM-levyasema, joka on laserlaite. Tällöin myös päälaitteena toimiva tietokone katsotaan laserlaitteeksi.

Kyseinen CD-ROM-livyasema on käyttäjän kannalta turvallinen luokan 1 laserlaite. Normaalisissa käytössä levyaseman suojakotelo estää lasersäteiden pääsyn laitteen ulkopuolelle.

HP 9000 Model 382 tietokoneen on tyyppi hyväksynyt Suomessa laserturvallisuuden osalta Työsuojeluhallitus, Työsuojeluhallituksen hyväksyntänumero TSH 222/6019/90. Laitteiden turvallisuusluokka on määritetty valtioneuvoston päätöksen No: 472/1985 ja standardin SFS-IEC 825 mukaisesti. Tiedot CD-ROM-levyasemassa käytettävän laserdiodin säteilyominaisuuksista:

Aallonpituus 780 nm

Teho 0,4 mW

Luokan 1 laser

VCCI Statement (Japan Only)

この装置は、第一種情報装置（商工業地域において使用されるべき情報装置）で商工業地域での電波障害防止を目的とした情報処理装置等電波障害自主規制協議会（VCCI）基準に適合しております。

従って、住宅地域またはその隣接した地域で使用すると、ラジオ、テレビジョン受信機等に受信障害を与えることがあります。

取扱説明書に従って正しい取り扱いをして下さい。

VCCI基準に適合する為に、シールドされたケーブルをご使用下さい。

Laser Safety Statement (For U.S.A. Only)

(For computers/controllers with a CD ROM drive installed.)

The CD ROM drive is certified as a Class 1 laser product under the U.S. Department of Health and Human services (DHHS) Radiation Performance Standard according to the *Radiation Control for Health and Safety Act* of 1968.

This means that the device does not produce hazardous laser radiation. Since laser light emitted inside the device is completely confined within protective housings and external covers, the laser beam cannot escape from the machine during any phase of user operation.

Warning

- **Use of controls, adjustments, or procedures different from those specified in this manual may result in hazardous invisible laser radiation exposure. None of the mechanisms within the CD ROM drive contain customer or field-replaceable parts.**
- **The CD ROM drive becomes a Class 3B laser mechanism when disassembled. If the CD ROM drive is disassembled, exposure to the invisible laser beam and hazardous invisible laser radiation could result in blindness.**

Do NOT disassemble the CD ROM drive for any reason.

Printing Conventions

This book uses the following typographical conventions:

If you see ...	It means ...
colored text	User input. Activate the designated button, choose the menu selection, or type the text shown. For example, more sample_file(Return) means you should type the characters and press (Return).
computer text	Text displayed by the computer system. For example, login: indicates a login prompt displayed by the system.
<i>italic text</i>	Variable text supplied by you. For example, file_name means that you type a file name of your choice. Italic text is also used for text emphasis and for document titles.
(Key)	Type the corresponding key on the keyboard. For example, (CTRL)-(D) means you hold down the (CTRL) key, and press the (D) key.
Displayed Item	Select an on-screen item or a corresponding softkey. For example, Help

Contents

1. Product Description	
The HP 9000 Model 382 Controller	1-1
Features:	1-1
Memory	1-3
Graphics	1-3
Built-In Interfaces	1-4
Internal Mass Storage Devices	1-7
Hardware Architecture	1-7
Operating Systems	1-8
2. Using Your Manuals	
Overview	2-1
Chapter Contents	2-1
Finding Documents for Specific Tasks	2-2
Hardware Installation	2-2
Software Installation	2-3
System Operation	2-4
Solving Problems	2-4
3. Starting Your System	
Chapter Contents	3-1
Initially Configuring Your System	3-2
Using the Command Line to Log In	3-3
Setting Up a User Account	3-5
Selecting a New Password	3-7
Running the passwd Command	3-8
Logging Out	3-9
Exiting Temporarily	3-10
Exiting (Logging Out) for an Extended Period	3-10
Exiting Using the HP VUE Front Panel	3-10

Shutting Down	3-11
Options for Your Starting and Working Environment	3-12
Activating the X Window System	3-12
Activating HP VUE	3-13
Logging In and Using HP VUE	3-14
Logging Out of HP VUE	3-15
4. Using the Command Line	
Chapter Contents	4-1
The Command Line Prompt	4-2
Running Commands	4-2
Working with Shells	4-3
Basics of Shells: Characteristics, Choosing and Using	4-3
Shell Features	4-4
Determining Your Login Shell	4-5
Using Key Shell: Visual Help for Korn Shell	4-6
Displaying the HP-UX Manual Pages from the Command Line	4-7
For More Information	4-7
Using Files and Directories with Command Lines	4-8
Creating Directories	4-8
Moving and Copying Files between Directories	4-9
Copying Files	4-9
Removing Files and Directories	4-10
Viewing and Printing Files	4-12
Printing a File with lp	4-12
Editing Files	4-14
Starting vi	4-14
Selecting Editing Functions	4-14
Positioning the Cursor	4-15
Saving Your Work and Quitting	4-15
For More Information on vi	4-16
Networking Overview	4-17
Copying Files Using ftp	4-18
Preparing to Use ftp	4-18
Transferring Files with ftp	4-19
Copying Files Remotely Using rcp	4-20
Logging In on Another Computer Using rlogin	4-23
Displaying Remote Graphical Programs Locally	4-24

Contents-2

For More Information	4-25
5. Backing Up, Restoring, and Updating Your Software	
Chapter Contents	5-1
Backing Up Your System and Software	5-2
Creating a Recovery System	5-2
Backing Up Your File Systems	5-4
Restoring Individual Files	5-7
Restoring Your Operating System Using the Recovery Tape	5-10
For More Information	5-12
6. Configuring HP-UX for Printers and Drives	
Chapter Contents	6-1
Preparing for Installation	6-2
Configuring HP-UX for a Printer	6-3
Testing the Printer Installation	6-5
Finding the Status of Existing SCSI Bus Addresses	6-7
Configuring for a Hard Disk Drive	6-8
Software Installation of the Hard Disk Drive Upgrade	6-8
Testing Your Installation	6-11
Configuring for a Flexible Disk Drive	6-12
Testing Your Installation	6-14
Archiving Files to a Flexible Disk	6-15
Retrieving Files from a Flexible Disk	6-15
Mounting a New Flexible Disk	6-16
Removing and Inserting a File-System Flexible Disk	6-17
Configuring for a CD ROM Drive	6-18
Installing the CD ROM Drive with SAM	6-19
Testing Your Installation	6-21
Mounting the New CD ROM Drive	6-21
Removing and Inserting a Disc	6-22
For More Information	6-23
Configuring for a DDS Tape Drive	6-24
Configuring the Drive on HP-UX	6-25
Testing Your Installation	6-27
DDS Tape Drive LED Indicators	6-28
Maximum Usage of DDS Cassettes	6-30
In Case of Difficulty	6-30

7. Dealing with Problems	
Chapter Contents	7-1
Interpreting Error Messages During Boot	7-2
Interpreting the LED Indicators	7-4
Dealing with HP VUE Problems	7-7
Logging In With HP VUE When All Else Fails	7-8
Re-Setting the VRX Special Device Files with mknod	7-9
Managing a Boot Failure	7-10
Boot Device Problems	7-12
Recovering from a System Panic	7-14
Procedures for Recovering from a System Panic	7-16
Dealing with Network Failures	7-20
A. Configuring the Boot ROM	
Appendix Contents	A-1
Using the Boot ROM Configuration Mode	A-2
Modifying I/O Configuration Information	A-4
Configuring for Automatic Operating System Selection	A-6
For More Information	A-9

Glossary

Index

Product Description

The HP 9000 Model 382 Controller

The HP 9000 Model 382 controller is object code compatible with most earlier Series 300 and Series 400 computers. Many capabilities of personal computers have been implemented. Key features include a low-cost 22 MIPS performance and a versatile I/O set including serial and parallel interface ports. Optional internal mass storage devices include hard and flexible disk drives and CD ROMs. VGA-resolution (640 by 480) graphics are used. Monitors are also supported with 1024 by 768 medium-resolution and 1280 by 1024 high-resolution color graphics. Graphics resolution is determined by the system board type and configuration.

Features:

- MC 68040 CPU operating at 25 MHz.
- ECC (SIMM) RAM configurable from 8 MB to 32 MB.
- Three graphics resolution versions:
 - 1024 by 768 medium-resolution; for 16-in. color monitors.
 - 1280 by 1024 high-resolution; for 19-in. color monitors.
 - 640 by 480 VGA-resolution graphics with 14-in. color or grayscale monitors.
- 25-pin RS-232 serial I/O port (expandable to 3 ports).
- One 25-pin HP Parallel port.
- One HP-IB port.
- SCSI port (optional).
- HP-HIL port for HP-UX keyboards and other HP-HIL devices.
- DIO-I and DIO-II interface slot direct connect expanders (optional interface boxes for connecting additional cards).
- DIO-I Accessory Card slot

- Ethernet IEEE 802.3 LAN, internal jumper selectable for AUI LAN or ThinLAN (optional).
- The Model 382 accommodates up to two mass storage drives. These include:
 - *One* of the following:
 - 3.5-in flexible disk drive.
 - CD ROM disk drive.

The additional drive can be selected from the following:

- 52 Mbyte hard disk drive (not supported on HP-UX).
- 210 Mbyte hard disk drive.
- 420 Mbyte hard disk drive.
- (The Model 382 will also accommodate hard disk drives in *both* positions.)
- A typical system would also include the following:

Product	Description
Controller (computer)	The system unit containing a hard disk drive with pre-loaded operating system, one accessory card slot, and optionally a flexible disk or CD ROM drive.
Keyboard	Connects to the controller via the HP HIL connector and used for input to the system.
Mouse	Connects to the keyboard and used to move the display cursor.
Monitor	Connects to the controller system and displays responses on its screen.
Bus expander (optional)	Stacks on top of the controller and accepts additional accessory cards. (See Figure 1-3).

- Operating systems:
 - HP-UX, factory installed, or installed from CD ROM or tape.
 - HP RMB/WS OS
 - HP RMB/UX OS
 - Pascal Workstation

1-2 Product Description

Memory

User-installable RAM boards provide user RAM in increments of 4, 8, and 16 Mbyte blocks. They have an Error Checking and Correcting (ECC) ability. Standard RAM is 4 MB, expandable to 32 MB.

RAM boards are used in pairs. There are four sockets on the system board for two-board pairs. RAM Upgrades are available as follows:

- HP A2210A; two 2 Mbyte RAM boards that add a 4-Mbyte block of memory.
- HP A2201A; two 4 Mbyte RAM boards that add an 8-Mbyte block of memory.
- HP A2202A; two 8 Mbyte RAM boards that add a 16-Mbyte block of memory.

Graphics

One of three system boards is used in the Model 382 controller. Each has different graphics circuitry. Table 1-1 lists the system boards and their graphics features for supported external monitors.

Table 1-1. Model 382 Controller Graphics Features

System Board	Resolution	Refresh Rate	Display RAM	Memory Planes	Supported Monitor
Medium-Resolution	1024 by 768	75 Hz	6 Mbits	8	HP A1497A/B Color
High-Resolution	1280 by 1024	72 Hz	16 Mbits	8	HP A1097A/B Color
VGA	640 by 480	60 Hz	4 Mbits	8	HP D1182 Color

Each system board has its own graphics ROM and specific graphics crystals to enable the different refresh rates and color.

Both color and grayscale graphics, as well as video, are available at the 15-pin rear panel video connector.

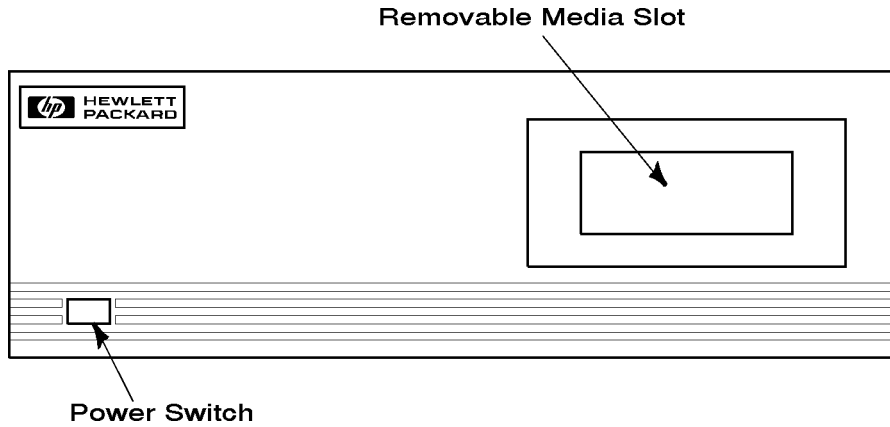

Figure 1-1. Model 382 Controller Front Panel

Built-In Interfaces

All the built-in interfaces for the Model 382 have their connectors on the rear panel as shown in Figure 1-2. The illustration shows the optional external SCSI and LAN connectors. The status indicator LEDs are also visible through the rear panel.

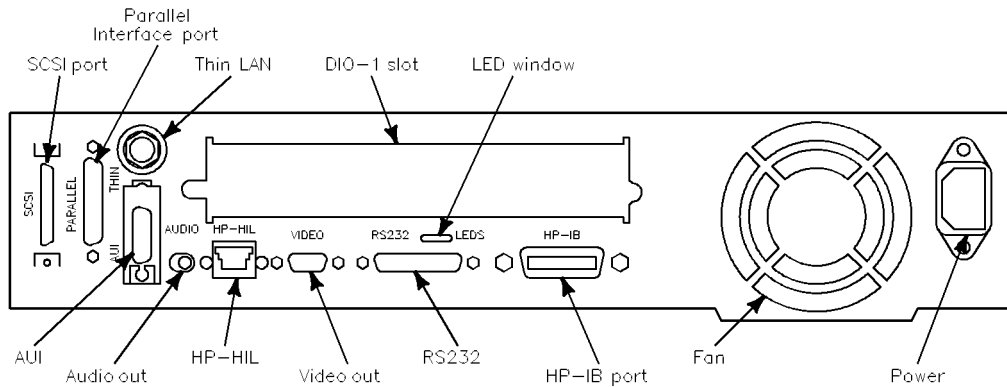

Figure 1-2. Model 382 Controller Rear Panel

1-4 Product Description

The Model 382 can be used with one or two optional expanders which serve to increase the input/output capacity of the controller. Figure 1-3 shows how two expanders would fit onto it.

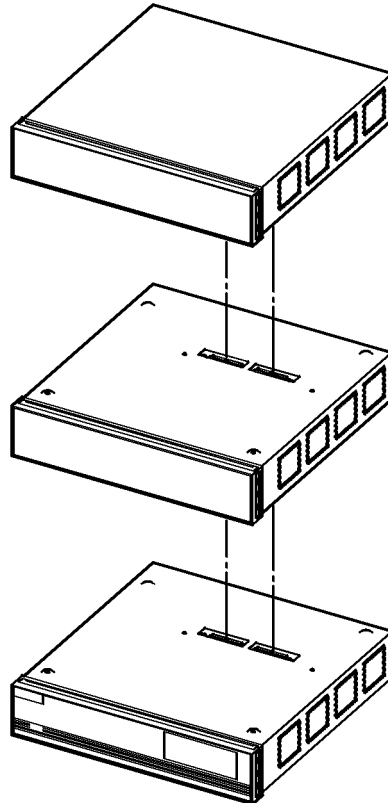

Figure 1-3. Model 382 with Two Expanders

Interface Descriptions

The SCSI interface uses a high-density, shielded external connector for use with external mass storage devices. Internally, a ribbon cable connects to optional mass storage devices.

The RS-232 serial interface is expandable from one port to three ports. The graphics circuit provides video for monitors.

A 25-pin HP Parallel port is provided for use with devices using the CentronicsTM interface protocols. Some configuration parameters are available under boot ROM control in Configuration Mode for internal interfaces.

The HP-HIL connector (rear panel) accepts a variety of HP-HIL input devices.

- HP 46021B Integrated Terminal Format (ITF) Keyboard.

Other HP-HIL devices may also be connected to the keyboard or HP-HIL connector.

An optional IEEE 802.3 Ethernet Local Area Network (LAN) is available to two ports:

- ThinLAN uses the BNC connector. An internal attachment unit interface is used.
- AUI LAN uses the 15-pin connector. An external attachment unit interface is required for use on the network.

Either port is activated by the system board LAN jumper position. Some LAN interface values can be configured by keyboard entry under Boot ROM control in Configuration Mode.

As with other Series 300 computers and controllers, audio tone output is provided, as well as an internal speaker.

1-6 Product Description

Internal Mass Storage Devices

The Model 382 may use up to two internal mass storage devices connected to the internal SCSI interface. It is available in diskless as well as disked configurations. Disked configurations for HP-UX have their hard disk drive bay fitted with either a 210 or 420 Mbyte preformatted hard disk drive. As an option, the HP-UX operating system may be preloaded. A second disk drive bay can have one of several optional mass storage devices installed.

Factory-installed and customer-installable mass storage devices include:

- HP A2258A 210 Mbyte Hard Disk Drive.
- HP A2259A 420 Mbyte Hard Disk Drive.
- HP A2252A 3.5-in. Flexible Disk Drive, which can be mounted on HP-UX, used with SoftPC™, or used for file exchange.
- HP A2253A CD ROM Disk Drive, which provides access to several data sets and multi-media applications, as well as to most HP software.

Hardware Architecture

Most of the functionality for the Model 382 is contained on one system board. All interface controllers, CPU circuits, memory controller and graphics/video circuits are on the system board. Either two or four RAM boards plug into sockets on the system board. Each mass storage device has its controller circuits on a PC board that is part of the device. Separate assemblies include the optional LAN board, and the fan and power supply assemblies.

Operating Systems

HP-UX 9.0 is supported on the Model 382. It is pre-installed on disked HP-UX systems and includes HP VUE 3.0, which can be activated after original boot. Users can start using the workstation immediately after hardware installation. Table 1-2 lists the features and languages for the operating system.

Table 1-2.
HP-UX Operating System and Languages for the Model 382

Operating system:	HP-UX 8.0 or later. HP-UX complies with XOpen, and POSIX specifications.
Languages:	ANSI/C, C++, Pascal, HP-UX FORTRAN/9000.
User interface:	X Window System 11R5 (OSF/Motif 1.2), HP VUE 3.0, HP SharedX.
Network Features:	IEEE 802.3/Ethernet Local Area Network: <ul style="list-style-type: none"> ■ S.25. ■ SNA. ■ RJE. ■ TCP-IP. ■ HP Diskless.

1-8 Product Description

Using Your Manuals

Overview

This *Owner's Guide* covers the information you will need for getting started with using HP-UX on your Model 382 controller. The topics include logging in and using your file system, editing files, installing upgrade devices, and backing up your system and files. In addition, Chapter 7 covers troubleshooting, if you should need it.

Chapter Contents

- In this chapter you will find references to manuals for additional tasks related to installing, configuring, and operating the HP 9000 Model 382 and its associated devices.
- For troubleshooting information, please see Chapter 7.
- If you need help with system hardware installation, see the *Installation Guide* for this system.
- If you do not have a pre-installed (Instant Ignition) system on your disk and you need installation information, see *Installing HP-UX 9.0*.
- If you have installed your system and want to get on with using it, skip to the second section of Chapter 3, “Using the Command Line to Log In” in Chapter 3.

Finding Documents for Specific Tasks

This section describes where to find the information you may need to install and start using your workstation.

Hardware Installation

Installation of this Equipment	Source Manual
Model 382, Keyboard, Mouse, and Monitor.	The <i>Installation Guide</i> for this system.
LAN Upgrade.	The <i>HP A2255A LAN Interface Upgrade Installation Guide</i>
Additional external peripherals.	The <i>Installation Guide</i> for the device and <i>Installing Peripherals</i> .
DIO-I and DIO-II Cards. (<i>Note that the DIO-II card requires an expander.</i>)	The <i>Installation Guide</i> for the card and <i>Installing Peripherals</i> .
CD ROM, Hard Disk, Flexible Disk drives	Chapter 6, in this manual and the <i>Installation Guide</i> for the individual device.
Network connections.	The <i>Installation Guide</i> for this system.

2-2 Using Your Manuals

Software Installation

Installation Task	Source Manual
Installing HP-UX.	<i>Installing and Updating HP-UX 9.0.</i>
Installing HP BASIC/UX.	<i>Installing and Maintaining HP BASIC/UX 6.2.</i>
Installing HP BASIC/WS.	<i>Installing and Maintaining HP BASIC/WS 6.2.</i>
Configuring the Boot ROM.	Appendix A in this manual and the <i>Hardware Configuration Guide</i> for this system.
Configuring the LAN interface.	The <i>Hardware Configuration Guide</i> for this system, the <i>HP 9000 Series 300, 400 and 800 Computers Networking Overview</i> , and <i>Installing and Administrating LAN</i> .
Entering the system name and network address.	Chapter 3 and Chapter 7 in this manual and the <i>Installation Guide</i> for this system.
Creating new user accounts.	Chapter 3 in this manual.
Setting or changing passwords.	Chapter 3 in this manual.
Setting permissions.	<i>Using HP-UX.</i>
Setting swap space.	<i>System Administration Tasks.</i>
Installing and using HP VUE.	<i>HP VUE User's Guide.</i>
Configuring X Windows.	<i>Using the X Window System.</i>

System Operation

Operation	Source Manual
Logging in and out of HP-UX.	Chapter 3 in this manual.
Logging in and running BASIC/UX.	<i>Using HP BASIC/UX 6.2.</i>
Logging in and running Pascal.	<i>Pascal 3.2 User's Guide.</i>
Starting and running the X Window System.	<i>Using the X Window System.</i>
Shutting down your system.	Chapter 3 in this manual.
Setting or changing passwords.	Chapter 3 in this manual.
Setting permissions.	<i>Using HP-UX.</i>
Entering commands in HP VUE.	<i>HP VUE User's Guide.</i>
Entering commands at a shell prompt (command line entry).	Chapter 4 in this manual, or <i>Using HP-UX.</i>
Using the directory/file system in HP VUE.	<i>HP VUE User's Guide.</i>
Using the directory/file system with HP-UX commands.	Chapter 4 in this manual, or <i>Using HP-UX.</i>
Using a shell.	Chapter 4 in this manual, <i>Using HP-UX</i> , or <i>Shells: User's Guide.</i>
Viewing a file in HP VUE.	<i>HP VUE User's Guide.</i>
Viewing a file using HP-UX commands.	Chapter 4 in this manual.
Editing a file.	Chapter 4 in this manual, <i>Using HP-UX</i> , or <i>The Ultimate Guide to the vi and ex Text Editors.</i>
Using basic network services.	Chapter 4 in this manual, <i>Using HP-UX</i> , or <i>Using Network Services.</i>
System backup/restoration.	Chapter 5 in this manual.
System security.	<i>HP-UX System Security</i> or <i>Using HP-UX.</i>

Solving Problems

For troubleshooting common problems, see Chapter 7 or Solving HP-UX Problems.

2-4 Using Your Manuals

Starting Your System

Chapter Contents

- Initially Configuring Your System.
- Using the Command Line to Log In.
- Setting Up a User Account.
- Selecting a New Password.
- Logging Out.
- Shutting Down.
- Options for Your Starting and Working Environment.

Initially Configuring Your System

If you have already loaded your HP-UX system and you have the “login:” prompt on your screen, go on to the next page.

3

If your system has HP-UX preloaded on its disk (this is indicated by a label over the power switch on your controller), HP-UX will automatically load itself when you first turn the power on. During this process, you will be asked for several pieces of information needed to configure your system appropriately:

- The time zone where your controller is located.
- The System name (host name) for your workstation: any alphanumeric, single-word name with eight or fewer characters.
- The network address number, also called an IP number, for your workstation. This consists of four address fields separated by periods: for example, *255.32.3.10*. You may need to consult with your system administrator for this information.

After you have assembled the hardware for your system, then have the above information ready before you turn on the power to your controller for the first time:

1. Turn on the power for your controller and display.
2. Enter the information when your system display requests it.

If you do not have the name, network i.d., and time zone information when you are prompted for it, you can use the default values now and enter this information at another time. You would enter the information later by typing:

```
/etc/set_parms systemname
```

The display will then prompt you for any information which is missing or which you may need to re-enter.

To review the steps of the boot process in detail, see the *Installation Guide* for this product.

3-2 Starting Your System

Using the Command Line to Log In

To log in the first time:

1. Type `root` at the “login:” prompt.
2. Press `(Return)`.

Since you haven't yet set a password, you will get a a system prompt (`#` for `root`), and you can begin using the system. To protect your data, do the following as soon as possible:

- a. Set up a password for `root`. See the section “Selecting a Password,” later in this chapter.
- b. Set up a “user” account. A user account provides the login environment for doing ordinary tasks with your system, while protecting you from accidentally changing or erasing critical operating system files. See “Setting Up a User Account”, later in this chapter to set up a user account.
- c. Set up a password for your user account.

Note

If you have additional (non-root) internal disk devices for your file systems, or if you have a DDS-Format (DAT) drive, you will need to be sure they are configured on HP-UX before you can access them.

If you have a factory-installed root disk with Instant Ignition (pre-installed HP-UX), the device files for any other included devices will already be in `/dev`. You will need to configure swap or file systems for additional hard disk drives, according to your needs, and then mount them. Use the SAM (System Administration Manager) to do this, by following the procedure in “Configuring for a Hard Disk Drive” in Chapter 6. Or see the *Installation Guide* for your device(s) for the details of the SAM procedures.

After you log in the first time as `root`, the default local login script prompts you to enter your terminal type as follows. You can respond by pressing `y` or `n` **Return**.

Is your console one of the following: a 2392A, 2393A, 2397A, or 700/92?
[y/n]:

If you respond `n` (or **Return**), you will see a row of numbers which asks you to determine the width (in columns) of your screen. Respond by entering the largest number you can see on the right (“128” is typical). If you are using a VGA display, enter the largest number you can see on the right *of the first line*.

Similarly, you will see a display of numbered rows. You will be asked to determine the row with the largest number, in the upper left. Respond by entering the largest number you see (“49” is typical). The system responds with a number (such as “300h”) which indicates the `TERM` setting for this session.

To Log In Later as User

You will use the procedure in the next section to set up a user account. Then, when you log in as `user_name`, your system displays the following during login:

```
TERM = (hp)
```

Pressing **Return** sets the `TERM` environment variable to “`hp`”, the default value. Generally, this is all you will need to do, since “`hp`” defines appropriate format values for Hewlett-Packard terminals.

3-4 Starting Your System

Setting Up a User Account

You can use SAM (System Administration Manager), to add a new user account.

If you aren't already logged in as root, type `exit` `(Return)` and log in as root. (You will see the `#` shell prompt whenever you are root).

To start SAM:

1. As root, type `/usr/bin/sam` `(Return)`.

The SAM opening menu will appear.

To run Sam on a character terminal (without a mouse), use the `(▲)` and `(▼)` keys to move the selection highlight up and down the menus ("select"), and press `(Return)` to "choose" a highlighted selection. Use function keys to activate choices in the (top) menu bar, to get help or for other functions.

Use `(Tab)` to activate other menu areas. When typing, use the `(◀)` and `(▶)` keys, `(Backspace)`, and `(Delete char)` for correcting mistakes.

2. At the opening menu, choose `Users and Groups->` by highlighting it, followed by pressing `(Return)` or selecting `Open`.
3. At the next screen, choose `Users`. After a pause, you will see a screen displaying a list of logins and real names.
4. Select `Add` from the `Actions` menu on the menu bar. On a character terminal, use the `f4` function key to activate the menu bar selections, and use the arrow keys to move to the one you want. You will see a form `Add a User Account`.

5. Fill in your login name, choice of start-up program and environment, if different from the defaults given. Supply the optional information as needed.

Note

On this form you can select the X Window System as your login default environment, if you so desire.

6. Activate **OK** (click on it, or press **Return** with **OK** illuminated) when you are finished.
7. You will be asked to select a password. (See “Selecting a New Password” for password requirements. If you wish, you can select a temporary password and reset it later). Type the password and press **Return**. Re-enter the password, as requested. The re-entered password must match the first.
8. Activate **OK**.
9. When the “Task Completed” message appears, activate **OK**.
10. In the **Users and Groups** screen, select **Exit** from the **List** menu (or double-click on the **-** in the upper-left corner), if you are using a mouse.
11. Choose the **Exit SAM** function key.
12. Type **exit** at the **#** prompt to log out of **root**.

3-6 Starting Your System

Selecting a New Password

After you have set up a user account and password, you may want to change passwords at a later time for security reasons.

Choose your new password according to these rules:

- The password must contain between six and eight characters.
- At least two characters must be letters (uppercase or lowercase).
- At least one character must be either of the following:
 - Numeric (the digits 0 through 9).
 - Special (neither letters nor numeric—for example, -, _, or \$).

According to these rules, the following are all valid passwords:

foo-bar \$money\$ Number_9 @rophy

Also, uppercase and lowercase letters are different. Thus, these are all different:

foo-bar Foo-Bar F00-BAR

When you choose a password, you want to ensure that no one can guess what you chose. If someone knows your password, that person may log in and access your files.

Running the passwd Command

When you've chosen your new password, set it by running `passwd`:

```
$ passwd
```

After you've entered the `passwd` command, the program leads you through these steps:

1. If you don't have a password, skip this step. If you *do* have a password, `passwd` prompts you to enter it.

```
Changing password for leslie      Your username appears here.
```

```
Old password: invisible old_password Enter your current password.
```

2. When you see the following prompt, enter your new password. (The screen will *not* echo what you type.)

```
New password: invisible password
```

3. Next, you need to re-enter the new password to verify it:

```
Re-enter your new password: invisible password
```

Now, when you log in again, use your new password.

3-8 Starting Your System

Logging Out

Caution

- If your system has its own disk and you are logged in on your local operating system, do not turn off power to your system without first shutting down its software according to the procedure in this chapter, “Shutting Down”. Turning off the power without first doing the shutdown procedure may result in damage to data on your disk.
- If you are running your system as a node in a cluster, and you have a mounted local file system disk, you must also perform the procedure in “Shutting Down”, or have your system administrator do so.

Using the command line (shell prompt), you can use either the `lock` command to secure your screen for temporarily leaving your workstation (and leave processes running), or you can log out of your current work session entirely. The following procedures explain `lock` and `exit`. Corresponding actions can be taken on the HP VUE Front Panel.

Exiting Temporarily

If you want to leave your workstation for a short time without logging out, enter the following:

`lock`

You will be asked to enter a password, which will not be displayed:

Key: *invisible password*

Again: *invisible password*

LOCKED

Now the keyboard cannot be used until you enter the password to unlock the system.

Exiting (Logging Out) for an Extended Period

The most common way to log out from the command line is by using the `exit` command:

`$ exit`

Exiting Using the HP VUE Front Panel

If you choose to run HP VUE (see “Activating HP VUE”), you can lock your screen temporarily by clicking on the lock icon (an icon of a padlock) on the lower left.

To log out using HP VUE, you can click on the “Exit” icon at the lower right. See *HP VUE User’s Guide* for further information.

3-10 Starting Your System

Shutting Down

Caution Turning off the power for your controller without first doing the shutdown procedure may result in damage to data on your disk. Always execute **shutdown** to completion first.

To shut down using the command line:

1. Log in as **root**. You can run **shutdown** *without* being **root** by being listed in the file `/etc/shutdown.allow`. See *System Administration Tasks* for details.
2. Enter the following:

```
shutdown -h
```

The **-h** option will cause the system to halt. You or anyone networked to your system will have a grace period of one minute to stop processes and save work before the system halts. (Use **shutdown -h 0**, if you want your system to stop immediately). You can then turn off the power when a message confirms that it is safe to do so.

Note Entering **shutdown** with *no* option will cause the system to halt after one minute and reboot in single user state. *It is not safe to your disk data to turn off the power with the system running.*

If your system runs a clustered network, entering **shutdown -h** also causes a message to be broadcast to networked users:

```
SYSTEM BEING BROUGHT DOWN IN ONE MINUTE
```

3. You will see a question:

```
Do you want to continue? (y/n)
```

- a. If you press **n** and **(Return)**, your workstation will not shut down.
- b. If you press **y** and **(Return)**, the shutdown process starts.

Wait for message: **Halted, you may now cycle power.**

4. You can now safely turn off the power for your controller.

Options for Your Starting and Working Environment

Your HP-UX contains the filesets to run either the X Window System or HP VUE (Visual User Environment).

3

To run either the X Window System or HP VUE, you will need:

- More than 12 MB of memory in your Model 382.
- At least a 1024 by 768 resolution monitor (color or grayscale).

Activating the X Window System

If you wish to run just the X Window System, without using the HP VUE file management features, you can select it as your login default environment when you create your new user account.

If you want to log in with the X Window System for the current session only, enter the following:

```
x11start
```

This will cause the X Window System to run, with system default settings, for the current login session. To change your startup environment to run the X Window System at each login, use SAM to make this change in your user account. See “Setting Up a User Account”, in this chapter.

For information on using the X Window System, see *Using X Windows*.

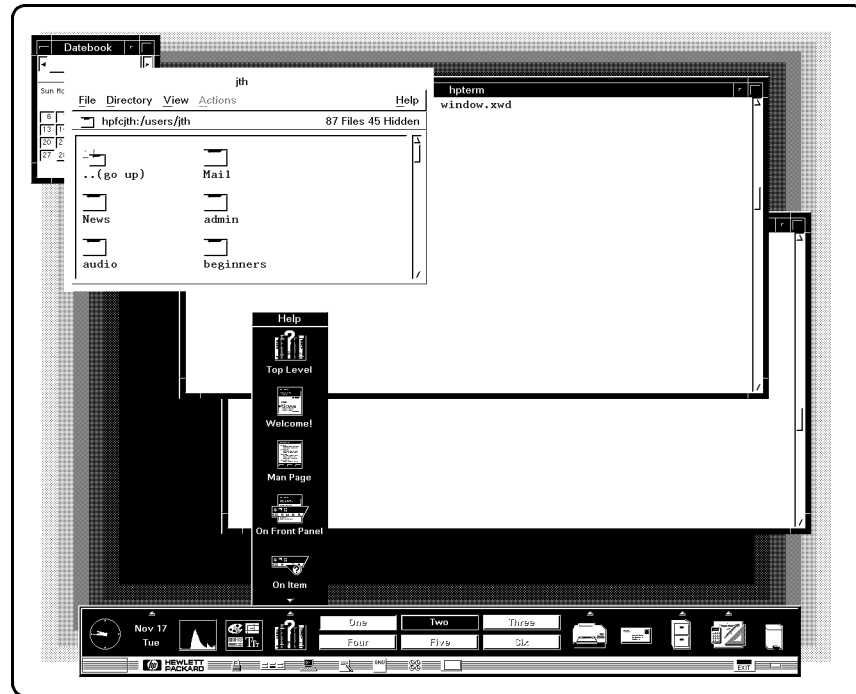

Typical HP VUE Workspace

Activating HP VUE

Before you activate HP VUE, first check that your system fulfills the following conditions in addition to those already given:

- The system hostname is listed in `/etc/hosts`.
- It has a console-based graphics display (at least 1024 by 768 resolution).
- It is able to run the X Window system.

If your IGNITION fileset is installed, you must run a script to complete the configuration of the Instant Ignition tools. The script will edit `/etc/inittab` (if it has not been extensively customized) and `/etc/newconfig/inittab` to launch HP VUE. It also registers the IGNITION tools so that they are recognized by HP VUE.

On a diskless cluster, this script must be run on each cnode that will run HP VUE and the Instant Ignition tools.

1. Log in as `root`.
2. To run the script, type :

```
/etc/newconfig/Ignition/configure.sh
```

The script will print out a success or failure message. If the script is successful, go on with the next section.

If a failure occurs, see the section “Dealing with HP VUE Problems” in Chapter 7.

Verifying Proper Operation

Once the installation of the IGNITION fileset has been completed and the `configure.sh` script has been run, you can start HP VUE by using the following method:

- Reboot your system
- Type `telinit 4; exit`

The HP VUE login screen should appear; if it does not, see Chapter 7.

Logging In and Using HP VUE

To login:

1. Use the HP VUE login screen to log in as `root`.
2. During the login process, if you need help logging in, click on the login screen `Help` button.
3. Your screen after login will have a slightly different appearance the first time you log in. You will see a `Welcome` window displayed along with the HP VUE Front Panel, the first time you log in. The information in the `Welcome` window will help you explore the capabilities of your system and perform some basic tasks.

3-14 Starting Your System

- 4. When you log in to HP VUE for subsequent sessions, you will see the Front Panel and the File Manager window for your home directory. You can still click on the ? on the Front Panel to get help information or the Welcome window information.
- 5. To get a terminal window with a shell prompt, click on the Terminal control button (a picture of a monitor and keyboard) on the Front Panel.

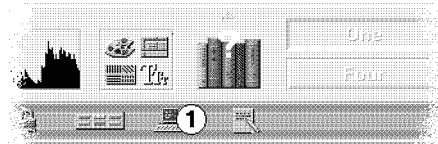

The HP VUE Terminal Button

- 6. To temporarily lock your screen, click on the Lock icon (a picture of a padlock) on the Front Panel.

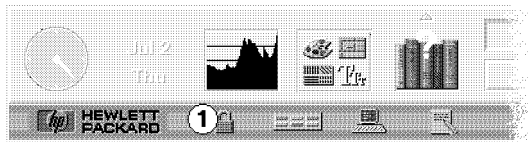
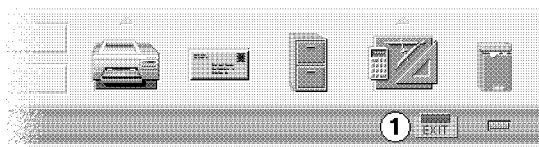

Figure 3-1. The Lock Button

Logging Out of HP VUE

To log out of a session, close your current files and click on the logout control on the Front Panel.



The Logout Control ①

For More Information

To find out more about configuring and using HP VUE and the X Window System, see the *HP VUE User's Guide* and *Using the X Window System*



3

4

Using the Command Line

Chapter Contents

- The Command Line Prompt.
- Working with Shells.
- Using Files and Directories with Command Lines.
- Viewing and Printing Files.
- Editing Files.
- Networking Overview.

4



The Command Line Prompt

Whenever you see the command line prompt, you can begin typing commands. If you are logged in as *user*, the command line prompt is either **\$** or **%**, depending on your shell. HP-UX displays the prompt every time you press **Return**.

Running Commands

To run a command, type the command's name after the prompt and press **Return**. The command then will begin running. When the command finishes, the prompt reappears. For example, run the following **whoami** command now:

```
$ whoami Return
leslie           Your user name appears here.
$                Then the command line prompt reappears.
```

If you make a mistake when typing a command, use the **Back space** key to back up and correct it.

(To make examples as clear as possible, this manual will *not* show the **Return** key at the end of each command line.)

4-2 Using the Command Line

Working with Shells

Whenever you enter a command you are making use of a command interpreter which interprets that command for HP-UX. The command interpreter is called a **shell**.

When you log in, you are said to be “in” a **shell**. HP-UX supports several different shells which behave in slightly different ways and give you varying amounts of interactive support at your display. These are called the Bourne, Korn, Posix, Key, and C Shells. The environment you select when you set up your user account determines which shell you get when you first log in, and you have the option of changing shells later.

Basics of Shells: Characteristics, Choosing and Using

HP-UX gives you your choice of several different shell-types which you can run: the Bourne, Korn, Posix, Key, and C Shells. Each of these shells has different characteristics, and you can increase the speed and efficiency with which you interact with HP-UX inside windows if you learn to use some of the built-in features of the shell of your choice.

For details on shell features and behavior, please see the *Using HP-UX* and the *Shells: User's Guide*.

Shell Features

Below are listed some of the features which may help you make a decision on which shell would be best for the kind of work you are doing:

Table 4-1. Comparison of Shell Features

Features	Description	Bourne	Posix Korn Key	C
Command history	A feature allowing commands to be stored in a buffer, then modified and reused.	No	Yes	Yes
Line editing	The ability to modify the current or previous command lines with a text editor.	No	Yes	No
File name completion	The ability to automatically finish typing file names in command lines.	No	Yes	Yes
<code>alias</code> command	A feature allowing users to rename commands, automatically include command options, or abbreviate long command lines.	No	Yes	Yes
Restricted shells	A security feature providing a controlled environment with limited capabilities.	Yes	Yes <i>(Not Posix Shell)</i>	No
Job control	Tools for tracking and accessing processes that run in the background. See <i>Shells: User's Guide</i>	No	Yes	Yes

4-4 Using the Command Line

Determining Your Login Shell

The command `echo $SHELL` displays the file name of the shell you entered when you logged in.

```
$ echo $SHELL
/bin/sh
$ _
```

Temporarily Changing Your Shell

Unless you are in a restricted shell, you can temporarily change your shell by using this command:

```
shell_name
```

where *shell_name* is the name of the shell (for example, `sh`, `ksh`, or `keysh`). Temporarily changing your shell lets you experiment in other shells. By typing the name of the shell you want to run, you *invoke* (enter) that shell, and the correct prompt is displayed. After experimenting in the new shell, return to your original shell by typing either `exit` or `CTRL-D`.

Permanently Changing Your Shell

To permanently change your *login shell* (the default shell you get when you log in), use the `chsh change shell` command:

```
chsh username shell_path_name
```

where *username* is your user name and *shell_path_name* is the full path name (e.g., `/bin/ksh`) of the shell you want as your default. After you use the `chsh` command, you must log out and log in again for the change to take effect. For example, if `terry` changes the default login shell to the Korn Shell, the command reads:

```
$ chsh terry /bin/ksh
$ _
```

Using Key Shell: Visual Help for Korn Shell

Key Shell gives you help on most HP-UX commands in Korn Shell by displaying softkey command-names and options in sequence. You can select from these and let Key Shell build your command lines “in English” before you have mastered the commands and command syntax of HP-UX.

Key Shell gives you softkey displays at the bottom of your screen which provide a “menu” of basic Korn Shell commands, along with their options in sequence. You will first see a status line like the following

```
$ █
=== hpfcjdp === /users/jodi/keysh === No mail === 09:55:07 AM =====
--Help-- Mail Change List hpterm Edit Display Print --More--
dir files file files files 1 of 4
```

Figure 4-1. Key Shell Softkey Display

You can enter commands from the Key Shell softkey menu or you can enter standard HP-UX commands as usual. If you enter standard HP-UX commands, Key Shell will often display an appropriate left-to-right set of menu options in the softkey label area at the bottom of your screen. Each label corresponds to a softkey, **f1** through **f8**. The **hpterm** at the center separates the softkeys into groups of four. You may select any or none of the options successively by pressing the corresponding softkey.

When you want to see more commands, or more options to go with a command you’ve already chosen, press the **--More--** softkey, **f8**. This will cause the Key Shell to display the next “bank” of softkeys in sequence, eventually cycling back to the first, if you press **f8** repeatedly.

After you make a selection by pressing a softkey, your choice will appear on the command line in “English,” just as it appeared in the softkey display, with the correct order and spacing.

4-6 Using the Command Line

Displaying the HP-UX Manual Pages from the Command Line

Type `man command_name` at the command prompt. For example, to learn more about the `cp` command type:

```
$ man cp
```

After a few seconds, an information display appears.

The message `- More -(11%)` means you've viewed 11% of the file, and 89% remains. (Some systems will just display `- More -`). At this point, you can do any of the following:

- Step through the file a page at a time by pressing the space bar.
- Scroll through the file a line at a time by pressing `(Return)`.
- Quit viewing the reference page by pressing `(q)`.

To print a `man` page for a command named `command`, enter the following:

```
man command | col -b | lp
```

You can use the `man` command to get a complete listing of HP-UX manuals by entering:

```
man manuals
```

For More Information

Your shell has many productivity-enhancing capabilities you may find useful. To learn about shells in detail, also refer to *Using HP-UX* and to *Shells: User's Guide*.

Using Files and Directories with Command Lines

The following gives you some basic information on using the HP-UX directory system. If you need more information on using files, directories, and command lines, see *Using HP-UX*.

Creating Directories

The `mkdir` (make directory) command creates a new directory. After you create a directory, you can move files into it, and you can even create more directories underneath it. For example, to create a sub-directory in your current working directory named `projects`, type:

```
$ mkdir projects
```

To verify that it worked, you can use either the `ls` or `lsf` command. Both commands display the new directory, but `lsf` appends a slash (`/`) to the end of directory names to differentiate them from file names. For example:

```
$ ls          List files, directories in your current working directory.
myfile projects  It worked!
$ lsf
myfile projects/  The lsf command appends a slash to directory names.
```

Figure 4-2 shows the resulting directory structure.

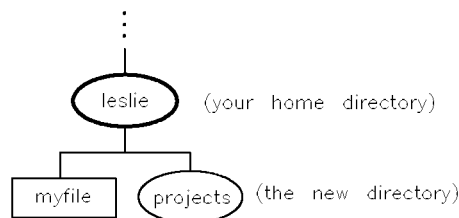

Figure 4-2. Creating the “projects” Directory

The general form of the `mkdir` command is as follows:

```
mkdir new_dir_path
```

where `new_dir_path` is the path name of the directory you want to create.

4-8 Using the Command Line

Moving and Copying Files between Directories

The `mv` command can be used to move files from one filename to another or from one directory to another. For example, to move `myfile` into the `projects` directory, type:

```
$ cd Move to your home directory first.
$ mv myfile projects
```

The general form of the `mv` command is as follows:

```
mv from_path to_path
```

where *from_path* is the file name or path name of the file you want to move, and *to_path* is the name of the path where you are moving the file.

Copying Files

To copy a file into a different directory, use the `cp` command. For example, to make a copy of `myfile` named `myfile2` in the `projects` directory, type:

```
$ cp myfile projects/myfile2
```

To make a new version of `myfile2` named `myfile3` in your current directory, type:

```
$ cp projects/myfile2 myfile3
```

The general form of the `cp` command is as follows:

```
cp from_path to_path
```

where *from_path* is the file name or path name of the file you want to copy, and *to_path* is the path name of the directory or file to which you are copying.

Caution

If you copy a file to a directory, even if the directory has the same name as the file, the directory will not be destroyed. But a file of the same name *in* that directory would be.

As a general rule, before using `mv` or `cp`, use `ls` or `lsf` to ensure that the target file name to which you want to move or copy doesn't already exist.

Removing Files and Directories

If you have files that are no longer needed, you should remove (delete) them. Deleting unnecessary files leaves more room on your system. For example, suppose you've finished using `myfile2`, and it is no longer needed. To remove `myfile2`, type:

```
$ rm myfile2
```

To remove an *empty* directory, type the following:

```
rm -r dirname
```

If there are any visible or invisible (“dot”) files still in the directory, this command will not be executed, and you will get a message that the directory is not empty. Also, if there are any subdirectories in the directory, you will get a message. In either case you can do the following:

```
cd dirname Any invisible “dot” filenames remaining will be displayed.
```

```
rm *
```

```
ll -a
```

```
rm .filenames You may have to repeat this command for all dot files.
```

```
rm -r * This removes any empty subdirectories.
```

```
cd .. To get to the parent directory again.
```

```
rm dirname
```

4-10 Using the Command Line

To avoid this process and remove a directory *and all its files and directories* in one action, type the following:

```
rm -rf dirname
```

Caution Use **rm -rf** with great caution, since it does remove a directory and all its contents, irretrievably, in one action.

Viewing and Printing Files

The `more` command displays a text file's contents on the screen. For example, the following line displays the contents of `myfile`:

```
$ more myfile
This is the text of "myfile", which I had previously
entered.
$
```

4

If the file contains more lines than are on your screen, `more` pauses when the screen is full. With a longer file, you can press `[space]` to continue looking at additional screens, and press `[q]` when you are finished. Then `more` returns you to the system prompt.

For using the `vi` text editor, see “Editing Files”, in this chapter.

Printing a File with `lp`

If your system is appropriately configured, you can print a text file using the `lp` (*line printer*) command. Before using the `lp` command you may need to find out whether your system is set up so that you can use the `lp` command. If it is not, basic installation information is in Chapter 6, in this manual. You can find detailed information on installing and configuring printers in *System Administration Tasks*.

If `lp` does work on your system, you may also need to find out the location of the printer, on an extensive system. When you have this information, print `myfile` by running the `lp` command:

```
$ lp myfile
```

If the `lp` command is working properly, it should display a message indicating that it sent your file to the printer. For example:

```
request id is lp-number (1 file)
```

The *number* is an i.d. number assigned to the print job by the `lp` command. If you don't see this message, or if you get an error message, consult your system administrator. If `lp` works successfully, you should get a printout with your username displayed on the first page. The time required for a printout depends on the number of tasks being run by the system and the speed of the printer.

To display a report on the printer status, including the order of your print job in the printer queue, type:

```
$ lpstat -t
```

To cancel a print job, enter the `cancel` command, with the i.d. number for your job:

```
$ cancel request_id
```

4



Editing Files

You can use the interactive text editor `vi` to enable you to view and alter text files, as well as to create new ones. This section introduces the basics of using `vi`. For detailed information, see *The Ultimate Guide to the vi and ex Text Editors*.

Starting vi

Start `vi` by entering the command `vi filename` at the prompt. If a file called `filename` exists, you will see the first screen of that file. If the file does not exist, it is created, and you will see a blank screen.

Selecting Editing Functions

The `vi` editor has several functional modes. When you enter `vi` you are in **command mode** and it is in this mode that you select all editing functions. Your selection determines what you can do to the text.

Press `(ESC)` to ensure that `vi` is in command mode. Then you can execute any of the following commands (among others):

- `i` (the insert command) Places your file in text mode and enters whatever you type preceding the cursor. Everything after the cursor will be moved to the right.
- `a` (the append command) Places your file in text mode and enters whatever you type after the cursor. The cursor moves to the right, and then text is inserted as with `i`.
- `x` (the delete command) Deletes the character that is highlighted by the cursor. This command does not put your document in text mode.





Each command in command mode allows you to perform only that function. For example, if you place your file in text mode by typing `r` (“replace a single character” command), then you may only replace one character. You are then placed in command mode, and you can return to text mode by typing `i` or `a` before inserting text.

4-14 Using the Command Line

Positioning the Cursor

The most commonly-used method to move the cursor is to use the **h**, **j**, **k**, and **l** keys. You can also use the arrow keys. These keys move the cursor as follows (press **ESC** first for command mode):

Table 4-2.

To Do This ...	Type This Command ...
Move the cursor right.	l or 
Move the cursor left.	h or 
Move the cursor up.	k or 
Move the cursor down.	j or 

4

Saving Your Work and Quitting

You can save your work with or without quitting **vi**. Your document must be in command mode for you to be able to use the following commands to save your work. Press **ESC** to ensure that your document is in command mode:

Table 4-3.

To Do This ...	Type This Command ...
Save without quitting vi	:w
Save and quit vi	:wq
Quit vi without saving changes	:q!
Save under another file name	:w <i>filename</i>
Save in an existing file and overwrite that file	:w! <i>filename</i>

For More Information on vi

The `vi` text editor comprises many more functions than are described in this brief introduction. Refer to *Using HP-UX* or *The Ultimate Guide to the vi and ex Text Editors* for more complete information about `vi`.

Networking Overview

Your HP-UX system can use a variety of networking services to enable you to transfer copies of files to or from other computer systems. These services can also enable you to log onto remote machines on the network and run commands and processes remotely.

This section gives you basic procedures for using the following networking functions:

- Copying files to and from a remote computer: `ftp`.
- Copying files remotely: `rcp`.
- Logging onto another computer on the network: `rlogin`.
- Displaying remote graphics programs locally.

For information on using HP-VUE on remote systems, NFS-mounting remote file systems, and exporting file systems to remote systems, see *Using HP-UX*, *HP VUE User's Guide*, or *Using Network Services*.

Copying Files Using ftp

The `ftp` file transfer program allows you to copy files between your local system and remote systems and among remote HP-UX, UNIX, and non-UNIX network hosts that support ARPA services. The `ftp` program not only allows you to perform remote file copying, but also facilitates file management operations such as changing, listing, creating, and deleting directories on a remote system for which you have a valid login or account.

Using `ftp` you can copy a local file to a remote file or vice versa. You can also append a local file to the end of a remote file. The file to which you are copying can have either the same or a different directory path and/or name as the one on the originating system.

Preparing to Use ftp

- Make sure that your `/etc/hosts` file contains entries for the remote hosts with which you will communicate.
- Have the system administrators for the remote hosts arrange to give you a password and an account, or a login guest account, so that you can log in on the remote hosts.

Transferring Files with ftp

1. To invoke `ftp` and connect to a remote host in one step, type the following:

```
ftp remote_hostname
```

This connects you to the remote host. `ftp` then confirms the connection and prompts you for a remote login name:

```
Name (remote_hostname):
```

If you intend to log in with the same remote login name as your local login name, just press **Return**.

2. Enter the password associated with your remote login name and `ftp` will confirm this action with a message and a confirmation that you are logged in:

```
Password (remote_hostname): invisible password
```

```
Password required for remote_login_name
```

```
User remote_login_name logged in.
```

3. If you are going to transfer binary (as opposed to “readable” text) files, type `bin` at the prompt, before proceeding.

- Use `get` to transfer files from a *remote host* to your *local directory*.

- At the `ftp>` prompt, type:

```
get remote_filename
```

The *remote_filename* is the name of a file in the remote working directory. In that case, `ftp` copies the file to the local working directory and gives it the same file name as the *remote_name*. If the file is in another directory on the remote host, *remote_filename* is the absolute or relative path for that file. The `ftp` program copies the file to a file name with the same path on your local system. (For example, `get /user/doc/filename`). If there is no matching path, `ftp` gives you a message, “**No such file or directory**”. If the destination file already exists, `ftp` overwrites its contents with the contents of the remote file.

When copying successfully, `ftp` gives you messages confirming the copy and the length of time it required.

- Use `put` to transfer files from your *local directory* to a *remote host*.

- At the `ftp>` prompt, type:

```
put local_filename remote_filename
```

- In this case, *local_filename* is copied to the remote file name in the specified remote directory.
 - *local_filename* can be the name of the local file in your current local working directory. `ftp` will copy the file into a file of the same name in *remote_file*.
 - *remote_filename* can be an absolute or relative path to a file name on the remote host. If not specified otherwise, it will be in the current working directory on the remote host.

4

General File-Manipulation Commands for ftp

See *Using HP-UX* for information on how to use `ftp` file-manipulation commands, such as `cd`, `mkdir`, `pwd`, and `rmdir`, many of which function in the same way as the corresponding HP-UX commands.

If you need information on any of the `ftp` commands, just type `help` (or `?`) at the `ftp` prompt.

Exiting ftp

To close the connection with the remote host and exit `ftp`, type:

```
bye
```

Copying Files Remotely Using rcp

You can copy files between HP-UX or other UNIX hosts on the network using `rcp`. Also, using appropriate options, you can copy directories between systems using `rcp`, if the configuration files that the service uses are set up properly.

Preparing to Use rcp

To use `rcp`, you'll need the following prerequisites:

- An account (login) on the remote host.

4-20 Using the Command Line

- A `.rhosts` file in the remote host home directory containing the names of your local host system and your local login name.
- A `.rhosts` file on your local system, as well. This contains the names of all the systems you will copy from. It will ensure that you will be able to use `rcp` when you use `rlogin` on the remote system.

Note A `$HOME/.rhosts` file creates a significant security risk. To prevent unauthorized users from gaining `remsh` access to your remote account and host, *only you* should be able to create and write to a `.rhosts` file in your remote home directory. Permissions need to be set accordingly.

- A `/etc/host` file on your local system which lists hosts with which you can communicate using ARPA/Berkeley Services. For each host, the file has a line containing information about the remote host in the following form:

internet_address official_name alias

You will find that the `/etc/hosts` file is useful for looking up names and addresses on the network. To facilitate such a lookup, use the `grep` tool described in `grep(1)` and in *Using HP-UX*.

Copying a Local File to a Remote Host

To copy from your system to a remote system, use the following syntax:

```
rcp local_filename remote_hostname:remote_filename
```

Note that, if `local_file` is not in your current directory, you will need to supply the relative path (to get from your current directory) or the absolute path (from `/`), in addition to the local file name. You will need to specify the complete (absolute) path for the `remote_filename` on `remote_hostname` only if you want it to go into a directory other than the remote home directory.

For example, to copy `myfile` from your current directory to a remote system called `xyz`:

```
rcp myfile xyz:/users/leslie/otherdir
```

In this case, `myfile` will be copied as `myfile` into the remote subdirectory, `otherdir`. If you had only supplied the remote host name, `rcp` would have copied `myfile` into the remote home directory, also as `myfile`.

You can also include a filename in the destination. For example, to copy to a system named `xyz`:

```
rcp myfile xyz:/users/leslie/otherfile
```

In this case, you have copied `myfile` as `otherfile`, in the remote directory `leslie`.

4

Copying a File on a Remote Host to Your Local Directory

Now, to reverse the process, here is how you would copy a file *from* a remote host into your local directory. Use the following syntax:

```
rcp remote_hostname:remote_filename local_filename
```

For example, to copy `myfile` from your account in a remote system `xyz` into your current directory:

```
rcp xyz:/users/leslie/myfile .
```

The dot (`.`) is shorthand for “current directory”. In this case, `myfile` will be copied as `myfile` from the remote directory into your current directory. You do not have to supply the destination filename if you don’t want to copy it to a new name.

If you want to copy `myfile` into another directory in your home system, use a path name, absolute or relative, as shown:

```
rcp xyz:/users/leslie/myfile otherdir/
```

Or, if you want to copy the file to another file name in another directory:

```
rcp xyz:/users/leslie/myfile otherdir/otherfile
```

Run the `ls` command to confirm what you have done.

4-22 Using the Command Line

Logging In on Another Computer Using rlogin

If you have an account on a **remote host**, then you can use **rlogin** to log in on a remote host by supplying your remote login name and password. You can then work on that system just as you would on your home system.

If the remote host is configured to allow it, you can also log in on a remote host automatically, without having to supply your login name and password.

Logging In on a Remote Host

- At the shell prompt, use the form:

```
rlogin remote_hostname
```

The *remote_hostname* is the name of an appropriately configured remote system. As before, this system is named in your */etc/hosts* file and in your *.rhosts* file. The remote host prompts you for your remote password.

- Enter your remote password. The remote host logs you in with the login message and the remote host prompt.

If for some reason you should make an error in entering your password, the remote host will give you the error message, “Login incorrect”, and will prompt you for your login, and your password:

```
Login incorrect  
login:
```

Getting the Same Working Environment on the Remote Host

To get the remote host environment to behave in the same way as your home environment, you can set the *.profile* or *.login* values to be the same by copying your local *.profile* or *.login* files to your home directory on the remote system. As with your home system, the values in your *.profile* or *.login* will take precedence over the values in the remote system’s */etc/profile* or */etc/csh.login* file.

Logging Out and Exiting the Remote Host

You can log out of the remote host just as you would from your home system, by typing:

exit

Typing **CTRL-D** also logs you out on most system.

At this point you are logged out of the remote host, disconnected, and returned to HP-UX on your local system, which displays a message and your local prompt:

```
Connection closed.  
$
```

4

Displaying Remote Graphical Programs Locally

If you are running HP VUE or the X Window System, you can run a program using windows on a remote machine and display the results locally. This is done by setting the `DISPLAY` environment variable on the remote system. `DISPLAY` sets the host, display number, and screen number to which a system sends bitmapped output for clients.

For example, if the remote machine is called *remote*, your local system is *local*, and the remote program is called `xwjit`, enter the following on your system:

```
xhost +remote      This enables your system to recognize the remote host.  
rlogin remote     Log in on a remote machine on which you have an  
account.  
DISPLAY=local:0.0 On the remote machine, set the DISPLAY variable to  
display on your local system.  
export DISPLAY    Export the variable  
xwjit            Run the program
```

For More Information

For detailed information on running HP VUE in a networked environment, see the *HP VUE User's Guide*.

Backing Up, Restoring, and Updating Your Software

Chapter Contents

- Backing Up Your System and Software.
- Restoring Individual Files.
- Restoring Your Operating System Using the Recovery Tape.

Backing Up Your System and Software

The most important part of your system is the data you have accumulated. It is also especially important to protect your operating system from corruption if your HP-UX has been supplied as a pre-installed “Instant Ignition” disk. You can protect your data and operating system from loss, using the general procedures given in this chapter. For detailed procedures, see *Installing and Updating HP-UX 9.0* or *System Administration Tasks*.

- Make sure you create and maintain a backup HP-UX kernel (`/SYSBCKUP`) on your disk from which you can boot in an emergency. A `/SYSBCKUP` is automatically created by SAM whenever you reconfigure and reboot a new kernel from your system console.

To build your backup system, you can use the following devices:

- Cartridge tape drives
- DDS Format (“DAT”) drives
- Magneto-optical disk drives
- Other hard disk drives

- Back up your file system regularly.

If you received your workstation with Instant Ignition, it is important to create your first recovery tape and to archive your existing file system *as soon as possible*.

Creating a Recovery System

A “recovery system” is a special tape containing a subset of the HP-UX operating system and some restoration tools. In the event of an operating system failure that prevents you from booting or logging into HP-UX, you can boot from the recovery system tape and use the tools on the tape to repair the file system on your disk. A recovery system is created by using commands rather than by using SAM.

You can also restore your system from a system CD ROM that you can purchase from your HP sales representative.

You should make a system recovery tape using `mkrfs` at the following times:

- Immediately after you set up your new workstation.

5-2 Backing Up, Restoring, and Updating Your Software

- Each time you update your operating system or make a change in your disk swap configuration.

To do this, you will need a tape drive (cartridge or DDS-format) and one or more tapes.

Using `mkrs` to Create a Recovery System:

The `mkrs` command constructs a recovery system on a tape or a formatted hard disk drive. If your system later becomes unbootable due to a corrupt root disk, then you can boot your system from the recovery tape or the alternate hard disk. Once booted on the recovery system, you can then use the tools it provides to repair the corrupt root disk.

Some Options for `mkrs`

If enough free disk space is available in `/usr/tmp` (typically 10-20Mb), the `-q` option can be used to make `mkrs` create an image of the recovery system in this directory before it copies it to the recovery medium. This option generally saves a great deal of time due to reduced seeking on non-random-access recovery medium (cartridge or DDS tape). For DDS-format tape recovery systems, the `-q` option is assumed.

When creating a DDS-format recovery system for a small memory workstation (8Mb or less), the `-s` option should be used to specify that a smaller set of files be placed on the recovery system.

See `mkrs(1M)` for more options with `mkrs`.

Source Device Files

By default, `mkrs` uses the following source device files:

```
/dev/update.src  
/dev/rct/c0  
/dev/rct
```

If none of the above defaults exist on your system, *one of these device files must be created* or the `-f` option must be used to specify the device file to be used. The recovery device file can be either block or character.

Root Device Files

mkrs, by default, uses the following device files for the root device:

```
/dev/dsk/0s0  
/dev/root  
/dev/hd
```

If none of the above defaults exist on the system, one of these device files must be created or the `-r` option must be used to specify the device file to be used. The root device file must be a block device file.

If You Have a Problem

An error message results if:

- None of the default device files for the recovery device exist and the `-f` option is not used to specify a recovery device file.
- None of the default device files for the root device exist and the `-r` option is not used to specify a root device file.
- The machine type cannot be determined and the `-m` option is not used to specify the machine type.

Backing Up Your File Systems

Preparation:

The following procedure sets up a scheduled backup:

1. If your system is more than six months old, you have non-HP supported software, or you have never done a backup before, see *System Administration Tasks* or *Installing and Updating HP-UX 9.0* before proceeding. Otherwise, SAM will provide interactive guidance. To use SAM, do the following:
2. Log in as `root`.
3. Type `/usr/bin/sam`.
4. Choose **Backup and Recovery** from the opening menu.
5. Choose **Backup Devices** (to determine what backup devices are connected) or **Automated Backups**.

5-4 Backing Up, Restoring, and Updating Your Software

- a. If you opened **Backup Devices**, and no devices are shown, make sure the device is connected and the tape is inserted.

Note If you have to connect a device during this process, choose **Refresh** from the **Options** menu.

- b. Choose the entry for the desired device.
 - c. Choose **Add an Automated Backup** from the **Actions** menu.
1. If you go directly to **Automated Backups**, you can select your local or remote backup device from **Actions** → **Add an Automated Backup** (Local or Remote) → **Specify Backup Device**. A form will display any existing backup devices.
 2. Before initiating the backup, verify that your tape is *not* write-protected by checking that the write-protect device is in “writable” position.
 3. Load a tape into the tape drive. Depending on what tape drive you are using, you may see activity lights flashing while the tape is loading. You can proceed when one light remains on, indicating that the drive is ready to accept data.
 4. From the **Add an Automated Backup** screen, you can select the options which will bring up additional forms for specifying the following required items:
 - a. **Select Backup Device** (if you have not already specified it).
 - b. **Select Backup Scope**: what filesets to include or exclude. The default is to backup the entire system.
 - c. **Select Backup Time**: time, day, date. You can also set whether you want a full or incremental backup, for each time specification.

5. **Additional Parameters** (optional) allows you to specify the following:
 - a. If you want your backups to cross NFS mount points.
 - b. If you want the tape (cartridge or autochanger) rewound.
 - c. If you want an index log to be created for each backup. (Results can be mailed to a designated user).
6. After the minimum required forms are filled out, SAM will then use your tape device to complete the backup according to your specifications.

Restoring Individual Files

To restore specified files from a local device using SAM, first you will need to have the following information and materials:

- A list of files you need.
- The media on which the data resides.
- The location on your system to restore the files (original location or relative to some other location).
- The device and device file for restoring the data.

Note

- To restore data to disks physically connected to another system, enter the **Remote Administration** functional area of SAM.
- When restoring files that are NFS mounted to your system, **frecover** can only restore those files having “other user” write permission. The **frecover** command normally operates in **user**-mode when crossing NFS mount points; not **root**-mode. To ensure that **frecover** can restore the files exported from the NFS server, login as **root** on the NFS file server and use the **root=** option to the **/usr/etc/exportfs** command to export the correct permissions. Refer to *exportfs(1M)* in the *HP-UX Reference* and the *Installing and Administering NFS Services* manual.

To Restore Individual Files:

1. Ensure that you have `root` capabilities.

2. Run SAM by typing:

```
/usr/bin/sam
```

3. Choose `Backup and Recovery`

4. Choose `Backup Devices`.

5. Highlight the device in the list from which the data is to be restored.

6. Choose `Recover Files or Directories` from the `Actions` menu and highlight `Select Recovery Scope`. Activate `OK` or press `Return`.

7. Choose the `Selected Files` checkbox (it should have an asterisk (*) in it. Do either of the following:

- Fill in the filename containing a list of files to restore. The filenames should be full pathnames. This file is *not* a graph file. This file is used to create a graph file. You can use the on-line index file created by a previous backup, but it must be edited to containing only the full pathnames of the files to be restored.
- Or enter each file name in the “Included” and “Excluded” boxes and choose `Add`. If you make a mistake, highlight the entry with the error and use `Modify` or `Remove` to correct the mistake. Only the “Included” box is required, if you choose this method.

You can use both the file and the included/excluded method simultaneously to specify files to be restored.

When you have completed determining the selected files to be recovered, activate `OK`.

5

5-8 Backing Up, Restoring, and Updating Your Software

8. To do any of the following during the restore process, activate **Set Additional Parameters** :

- Overwrite new files.
- Maintain original ownership.
- Recover files using full path name, or
- Place files in a non-root directory.

Turn on the appropriate checkbox(es).

To restore files relative to a particular directory, fill in the directory.

Activate the **OK** control button to set the additional parameters.

9. Activate the **OK** control button to start the restore process.

If confirmation messages appear, read the message(s) and activate the **OK** control button to proceed in each case. SAM displays a window containing the output of the executed **frecover** command.

Restoring Your Operating System Using the Recovery Tape

If your operating system or the entire root disk becomes corrupted and not usable, you can restore your system using your recovery system tape and your archive backup tape(s). Also see Appendix A for information on using the Boot ROM to find and boot from a recovery tape.

If your operating system is still usable but not functioning correctly, you can load the fileset **TOOL** from an update tape to obtain diagnostic utilities,

You can boot a memory-based version of **hp-ux** (known as a *recovery system*) from the tape cartridge or DDS-format recovery tape which you have made. From the recovery system, you can mount and unmount file systems, run **fsck** to check and repair file systems, copy files back onto your system disk, and various other tasks.

5

Caution Do not run **fsck** on a file system that is mounted and active. This could introduce data corruption. Run **fsck** in single-user mode when checking the root file system. For file systems other than the root file system, unmount the file system, run **fsck**, and then remount the file system.

If your system disk (including **/SYSEBCKUP**) is unbootable, do the following:

1. Load the recovery tape in your tape drive and be sure that the drive is turned on.
2. Wait for the drive to become ready (the “busy” light remains off).
3. Reset your computer by turning it off and then back on. Boot the system and pause the boot process by pressing **(ESC)** after the computer performs its color self-test and prompts for boot selection.

5-10 Backing Up, Restoring, and Updating Your Software

4. At the boot selection screen, select the operating system that is on the tape drive as the one you want to boot from. For example, for the tape drive:

```
...  
  
1R    SYSRECOVERY  
...
```

Enter **b** and the *device_specification* , such as **1R**:

```
b device_specification
```

5. Your recovery system should begin loading from the tape. Once your recovery system is up and running you will have a minimum set of commands to use, in order to help you repair and restore your primary (disk-based) operating system.
6. From this point, the specific things you need to do to recover your primary system depend on the nature of the boot problem. Some of the things that you might need to do are outlined in the following list:

Note If your inability to boot your system is caused by faulty hardware, it will be necessary to have that hardware repaired before you can proceed with the items in this list.

- a. You might need to run the **fsck** program to repair your root file system. *Do so in single-user mode only.*
- b. The **/hp-ux** kernel file can be restored, if it has been corrupted or removed, by doing the following:
 - i. Mounting your system disk to an empty directory (make one if necessary) in your memory-based recovery system.
 - ii. Using the **cp** command to copy the **/hp-ux** file from your memory-based system (it is a copy of your *real* **/hp-ux** file) to the directory you used as a mount point for your system disk. The destination file should be called **hp-ux**.

- c. You might need to restore important system files such as `/etc/inittab`, `/etc/rc`, etc. from your memory-based system to your system disk. The procedure for doing this is almost identical to the procedure for restoring `/hp-ux`. Only the file names and directories will be different.
- d. You might also need to move, remove, copy, or search for other files.

Note that the memory-based system has limited capabilities. Your primary objective is to restore your disk-based system to a bootable condition and then reboot your computer from your system disk. From that point, you can recover lost files from backup tapes, or whatever else is necessary to restore your system to its normal operational condition.

For More Information

For more information on backup and recovery, see *Installing and Updating HP-UX 9.0*, *System Administration Tasks*, and the references for `mkr`(1m), `cpio`(1), and `tcio`(1) in the man pages or in HP VUE Help. Also see *Solving HP-UX Problems*.

Configuring HP-UX for Printers and Drives

Chapter Contents

- Preparing for Installation.
- Configuring HP-UX for a Printer.
- Finding the Status of Existing SCSI Bus Addresses.
- Configuring for a Hard Disk Drive.
- Configuring for a Flexible Disk Drive.
- Configuring for a CD ROM Drive.
- Configuring for a DDS Tape Drive.

Preparing for Installation

If your system was shipped with its internal mass storage devices factory-installed, you will not need to do further installation to enable the device to communicate with HP-UX. If you have purchased a new (upgrade) device, you will have to install it on HP-UX. You may also have to do some configuration for appropriate data interchange with a new printer. This chapter gives you general guidance for these tasks.

For peripherals devices in general:

- For a list of device upgrades which are supported by the Model 382 see “Internal Mass Storage Devices” in Chapter 1.
- See the *Installation Guide* for the device you are installing for information on hardware installation. You can also get installation information from *Installing Peripherals*.
- Ensure that each new device you install which communicates through the SCSI protocol has a *unique bus address*. You can use `/etc/ioscan` (see “Finding the Status of Existing SCSI Bus Addresses”) to determine this, or you can use SAM (System Administration Manager). The factory-set SCSI addresses for the upgrade devices in this chapter are as follows:
 - Hard Disk Drive: 6
 - Flexible Disk Drive: 0
 - CD ROM Drive: 2
 - DDS Drive: 3
- This chapter shows you how to use basic SAM (System Administration Manager) procedures. SAM will determine the status of any of your connected devices and will perform many installation tasks for you.

If you don't want to use SAM, or it is not on your system, you can also HP-UX commands directly to accomplish the same tasks. For information on using manual system administration procedures, see *System Administration Tasks*.

6-2 Configuring HP-UX for Printers and Drives

Configuring HP-UX for a Printer

You will need to supply certain items of information needed to identify the printer you are installing. It will help to have this information available to refer to during the software installation process:

■ **Printer Interface:**

- Parallel: _____
- Serial (RS232) Port 1: _____
- Serial (RS232) Port 2: _____

■ **Printer Name** (a name the system uses to identify the printer. It can be any name.):

■ **Printer Model Number** (located on a label on the back of the printer):

Procedure:

To install your printer:

1. Log in as `root`. Make sure you have a printer connected.
2. Run SAM by typing the following, and then pressing **Return**:

```
/usr/bin/sam
```

To get help in SAM, pressing the **F1** key gives you context-sensitive information for the object at the location of the cursor.

In case you are not using a mouse, arrow keys and **Tab** also are used for moving the highlighted areas around the screen. Activating by pressing **Return** with **OK** illuminated is equivalent to clicking the mouse on **OK**. See *Using HP-UX* for the details of keyboard equivalents.

3. At the SAM opening screen, choose (highlight and open) **Printers and Plotters**.
4. Choose **Printers/Plotters** from the next screen.



If your workstation doesn't have any printers connected, you will see a message. If you get this message, activate **OK** or press **Return** while **OK** is illuminated.

5. From the **Actions** menu (on the menu bar at the top of the Printer/Plotter Manager window), choose **Add Local Printer/Plotter**.
6. Choose an appropriate selection on the sub-menu giving options for Parallel, Serial, HP-IB, etc.
7. A window for the type selected will give you information on available interfaces.
8. If you chose **Add Serial (RS-232) Printer/Plotter**, more than one serial interface could be listed. The RS-232 interfaces are listed in ascending order. The lowest-numbered RS-232 interface corresponds to the lowest-numbered RS-232 connector on your system. Choose the one to which you have connected your printer.
9. Activate **OK**.

The window opens for **Add Local Printer/Plotter**.

10. Select the box labeled **Printer Name** and enter your *printername* for the new printer (as entered in this manual earlier).
11. Choose **Printer/Model Interface**.
12. Scroll down the next screen to find the Model Name of your printer.
13. Choose the Model Name.
14. Activate **OK**.
15. In the **Add Local Printer/Plotter** window which reappears, choose the box labeled **Make this the system default printer** (unless you want to add the device as an *alternate* printer).
16. Activate **OK**.
17. If you are running HP VUE, you will be asked a question about adding the printer name to the VUE **Printers** subpanel.

6-4 Configuring HP-UX for Printers and Drives

18. If the print spooler was not previously running, a window will appear with the question: `Do you want to start the print spooler now?`. Select `Yes` and press `(Return)`.
19. You will see a confirmation screen asking if your printer is turned on, connected to your system, and online. Check your printer to ensure that it is ready, and press `(Return)`.
20. You will see the message `Task completed`. Press `(Return)`.
21. Exit the task and choose `Exit SAM`.
22. Enter `exit` to exit `root` and return to `user` status.

Refer to *System Administration Tasks*, for additional SAM information.

Testing the Printer Installation

If you made your printer the default system printer, enter the following commands to test it:

```
cd
```

```
lp .profile (Return)
```

(If your printer (called *printername*) isn't the default system printer, enter the following command to test it:)

```
lp -dprintername .profile
```

The file named `.profile` should print out on your new printer.

Dealing With Printer Problems

If you experience problems in printing, ensure that the following are correctly installed:

- The power cord for the printer is plugged in.
- The printer is turned on.
- The printer selection switches are set for online.
- Paper is loaded into the printer (and it isn't jammed).
- The correct interface has been set up.
- The printer cable is connected to the correct interface port on your printer.
- The cable is connected to the correct port on your system.

Finding the Status of Existing SCSI Bus Addresses

Before you install a new SCSI drive, to ensure that the SCSI bus address of your device is currently unused, you can use SAM, or you can use the `ioscan` tool to help determine which devices are currently connected. To determine the currently connected SCSI bus IDs, enter the following command line:

```
/etc/ioscan -fb
```

The result will be a display of information, such as the following:

```
Class      H/W Path  Driver   H/W Status   S/W Status   Description
=====
...
disk       2.0.1.2.0 scsi     ok(0x5800101) ok           TOSHIBA CD-ROM
tape_drive 2.0.1.3.0 scsitape ok(0x1800202) ok           HP      HP35450A
disk       2.0.1.6.0 scsi     ok(0x101)    ok           MICROP  1528
...
```

For example, the SCSI bus address for the “MICROP” disk device is in the fourth column of its hardware address as “6” (2.0.1.6.0). If you were installing another disk, for file system use, it would best be accessed at the adjacent SCSI bus address in the “scanning” order, “5”. In any event, SAM will help you determine an available device file, corresponding to any unused SCSI address setting, when you do the installation.



Configuring for a Hard Disk Drive

Hard disk drive upgrades can be installed to accommodate local file systems and swap space on your workstation.

Software Installation of the Hard Disk Drive Upgrade

After hardware installation has been completed (see the *Installation Guide* for this device), you'll need to ensure that your operating system is prepared to exchange data with the device. This section provides instructions for configuring HP-UX to communicate with a hard disk drive upgrade. Note that your HP disk is pre-formatted.

Caution Although the device is well-protected from physical shock when installed in the workstation, it is very easily damaged when separate. Avoid dropping or striking a device.

The factory-set SCSI bus address for the disk drive:

- For an upgrade disk drive: SCSI bus address: 6

This SCSI address assumes usage of the disk as `root`. Although the configuration jumpers in the back of the drive are factory-installed and should not require reconfiguring, it is possible that the SCSI bus address jumpers for an upgrade may be shipped with different settings. Therefore, please see the *Installation Guide* for the drive for the procedure for resetting jumpers, should it be necessary.

The following list outlines the software procedures you'll find in this section for installing the hard disk drive as a file system disk:

- Use SAM to do the following:
 - Configure an unused device file with the select code and bus address for your device.
 - Build a file system on the disk.
 - Mount the disk so that you can access it as a file system.

6-8 Configuring HP-UX for Printers and Drives

Note

■ SAM does not support the following:

- Changing the hardware address of a disk drive containing the root file system.
 - Changing the hardware address of a disk array.
 - Changing the hardware address of a disk that is part of software disk striping.
-

After hardware installation has been completed (see the *Installation Guide* for this device), you'll need to ensure that your operating system is prepared to exchange data with the device. This section provides instructions for doing this.

1. Run SAM by typing the following:

```
/usr/bin/sam
```

Pressing the **(f1)** key gives you context-sensitive information for the object at the location of the cursor.

2. Choose **Disks and File Systems**.
3. Choose **CD-ROM, Floppy, and Hard Disks**.
4. From the **Actions** menu, select the item **Add a Hard Disk Drive**.
5. From the screen which appears, select the step **Select a Disk to Add**.
6. You will see a list of unused drives. Choose the disk you want to add from this list.
7. If the device you have just connected doesn't appear, activate **Device Missing**, and you will be given the following options:

- a. Have SAM rescan the system for the device. If you have connected the device *after* starting SAM, you should activate **Yes**. Otherwise, activate **No**.
 - b. Respond to the confirmation screen regarding whether the device is connected and powered up.
 - c. Respond to the confirmation screen regarding whether additional device drivers are needed. (Unless the kernel has, for some reason, had drivers removed, the drivers needed for a hard disk should currently be in the kernel.)
 - d. You will be given an information screen suggesting things to try if the device still cannot be found. If this is the case, you will need to consult *Installing Peripherals*.
8. After you choose the device, you will see a form giving three tasks:
- a. **Select a Disk to Add**. (You have already done this).
 - b. **Set Disk Usage and Options**.
 - c. **Modify Defaults...**. (This task is optional).

Choose **Set Disk Usage and Options**.

9. On the form which appears, select how you want to use the disk (“File System”, “Swap”, or both). Activate **OK** when you have finished this step.
10. If you want to modify the defaults, complete the information screen for this step. Then activate **OK**.
11. You will be returned to the **Add a Hard Disk Drive** form. Activate **OK** to exit this form.
12. A “Messages” Box appears, reporting the progress of the task. When the task is finished, activate **OK**.
13. Exit SAM. (SAM copies your original `/etc/checklist` to `/etc/checklist.old`).

6-10 Configuring HP-UX for Printers and Drives

Testing Your Installation

A simple test to make certain that the drive has been installed correctly (whether it is mounted or not) is to execute the command `diskinfo` (using the appropriate character device file name as the argument). For example, enter the following at the shell prompt:

```
diskinfo /dev/rdisk/6s0
```

If the disk is installed correctly, `diskinfo` will display a listing of information about it, such as the following:

```
SCSI describe of /dev/rdisk/6s0
  vendor: Quantum
  product id: PD210S
  type: direct access
  size: 200000 Kbytes
  bytes per sector: 512
```

After mounting a new disk on a directory, enter `ll` at the shell prompt to get a directory listing. This should give you at least one file or directory entry. For example:

```
total 1024
drwxr-xr-x  2 root  root      8192 Aug 31 15:24 lost+found
```

6

Configuring for a Flexible Disk Drive

Caution Although the device is well-protected from physical shock when installed in the workstation, it is very easily damaged when separate. Avoid dropping or striking a device.

Note the flexible disk drive jumpers are pre-configured correctly at the factory. It should not be necessary to change jumper settings.

The factory-set SCSI bus address for the drive:

- SCSI bus address: 0
-

Note On this device, an installed address jumper is a logical 0, contrary to the practice with most other SCSI devices,. Thus, *all three address jumpers are normally installed.*

As it is possible that the SCSI bus setting for an upgrade may be shipped differently, please check the jumpers before installation. See the *Installation Guide* for the device for the procedure for resetting the device, should it be necessary.

After hardware installation has been completed, you'll need to ensure that your operating system is prepared to exchange data with the device. This section provides instructions for doing this.

1. If you wish to initialize a new disk, make sure you have the disk loaded in the drive.
2. Run SAM by typing the following:

```
/usr/bin/sam
```

To get help in SAM, pressing the **(f1)** key gives you context-sensitive information for the object at the location of the cursor.

3. Choose **Disks and File Systems**.
4. Choose **CD-ROM, Floppy, and Hard Disks**.

6-12 Configuring HP-UX for Printers and Drives

5. From the **Actions** menu, select **Add a Floppy Disk Drive...**. You will see a list of unused disks, including the new one you have connected.
6. Choose the line identifying the model of the new disk.
If the device you have connected does not appear on the list:
 - a. Check your hardware connections, and make sure that the device is turned *on*.
 - b. Activate the button **Device Missing**, and you will be given the following options:
 - i. Have SAM rescan the system for the device. If you have connected the device *after* starting SAM, you should activate **Yes**. Otherwise, activate **No**.
 - ii. Respond to the confirmation screen regarding whether the device is connected and powered up.
 - iii. Respond to the confirmation screen regarding whether additional device drivers are needed.
 - iv. You will be given an information screen suggesting things to try if the device still cannot be found.
7. After you highlight the device, note that the **Initialize disk** button is toggled *on* (the default). Activate this button to turn it *off* if you do not wish to initialize a disk (or if the disk is preformatted).
8. Activate **OK** when you have finished with this form.
9. A “Messages” Box appears, reporting the progress of the task. When the task is finished, activate **OK**.
10. Exit SAM. (SAM copies your original `/etc/checklist` to `/etc/checklist.old`).

Testing Your Installation

A simple test to make certain that everything has been installed correctly is to execute the command `diskinfo`.

1. Make sure a flexible disk is inserted in the drive (otherwise, a core dump may result).
2. Type the following, using the appropriate device file name as the argument.
For example:

```
diskinfo /dev/rfloppy/0s0
```

If the disk is installed correctly, `diskinfo` will display a listing of information about it, such as the following:

```
/dev/rfloppy/0s0
SCSI describe of 0.rdisk:
    vendor: TEAC
    product id: XXXXXXXX
    type: direct access
    size: 1400000 bytes
    bytes per sector: MNM
```

6

If you wish to test the installation of your flexible disk drive *without* a disk installed, use the `ioscan` command.

6-14 Configuring HP-UX for Printers and Drives

Archiving Files to a Flexible Disk

Data can be stored on flexible disk media in a variety of formats. The capacity of these devices is generally too small to hold useful HP-UX file systems. Instead, DOS or LIF file systems are commonly used. Data can also be stored in an archive-utility format. For example, `tar` and `cpio` are commonly used to share data with other HP-UX systems.

See the man pages or *HP-UX Reference* references *dosif(4)* and *lif(4)* for detailed descriptions of the file systems. For information on `tar` and `cpio`, see *tar(1)* and *cpio*.

To save files archivally to a flexible disk using `tar`, use a formatted disk and enter the following command line, where *pathname* is the directory where the files reside:

```
tar -cvf /dev/rfloppy/0s0 pathname
```

Retrieving Files from a Flexible Disk

To list files stored in a `tar` archive on a flexible disk, without transferring them to your hard disk, use the following command line:

```
tar -tvf /dev/rfloppy/0s0
```

This lists all the files on the flexible disk.

To transfer or restore files from a flexible disk to your hard disk drive, do the following:

1. Load the source disk into the flexible disk drive.
2. Using `cd`, make sure you are in in directory you want the files to reside in.
3. Enter the following command line to restore *pathname* on the disk to your current directory:

```
tar -xvf /dev/rfloppy/0s0 pathname
```

Mounting a New Flexible Disk

If you want HP-UX to be able to address a newly-inserted flexible disk as a small file system, you will need to mount it. Execute the following to mount the new disk. For example, using “/flex” as the mount directory:

```
mount /dev/floppy/0s0 /flex
```

See the next section for information on mounting and unmounting a disk used as a file system.

Removing and Inserting a File-System Flexible Disk

Caution If you wish to use the disk as a mounted file system, you must mount it every time you insert it into the drive, and you must unmount the disk before you eject it from the drive.

You will need to do the following:

■ Before you remove a disk:

1. Temporarily unmount the file system for the disk by executing the following. For example, if the disk is designated by the block device file `/dev/floppy/0s0`:

```
umount /dev/floppy/0s0
```

2. Remove the disk.

■ After you insert a disk:

1. Mount the disk file system so that HP-UX will recognize it. If, for example, you are mounting the disk in a drive designated by the device file `/dev/floppy/0s0` under a pre-existing directory `/flex`, execute the following:

```
mount /dev/floppy/0s0 /flex
```

(Note that the directory `/flex`, in the example, must be given an absolute path name).

In this example, the `mount` command announces to the system that a removable file system is to be attached at the directory `/flex`.

2. Now you can access the flexible disk as you would any other disk.

Configuring for a CD ROM Drive

You can use a CD ROM (“Compact Disc Read-Only Memory”) drive to accommodate read-only use of a wide variety of software, including HP-UX system updates.

After hardware installation for a drive has been completed (see the *Installation Guide* for this device), you’ll need to ensure that your operating system is prepared to exchange data with the device. This section provides instructions for configuring HP-UX to communicate with the CD ROM drive.

Note ■ The CD ROM drive cannot be locally-mounted on a diskless node, although its driver must be configured into each cluster node’s kernel.

This section deals with the following topics:

- Installing the CD ROM with SAM.
- Testing the installation.
- Mounting the new CD ROM.
- Removing and inserting a disc.

The factory-set SCSI address for this device:

- SCSI bus address: 2

As it is possible that the CD ROM drive may be shipped with a different SCSI bus setting, please see the *Installation Guide* for the device for guidance on resetting it, if necessary.

Inserting the disc in your CD ROM drive.

Note that a rigid plastic caddy holds and protects the disc. Before inserting the disc, make sure you have the disc installed in the appropriate disc caddy. When inserted into the disc port, data is read from the disc through a shutter in the caddy. When you eject the caddy, the shutter closes to protect the disc’s data surface.

The disc caddy for an HP upgrade drive, such as the HP A2644A, is not interchangeable with the HP C1707A CD ROM Drive disc caddy. However,

6-18 Configuring HP-UX for Printers and Drives

you can remove the disc from one caddy and use the other, if necessary, in order to fit the appropriate drive. Disc caddies are available from Hewlett-Packard.

Caution Do not open the disc caddy shutter manually. Opening the shutter will expose the disc's data surface to dust and damage. If the data surface gets too much dust or damage, its readability by the CD ROM drive's laser read head will be reduced.

Installing the CD ROM Drive with SAM

It is a good idea to make a note of your CD ROM drive model and its hardware address (select code and bus address), before you do the software installation.

- CD ROM Model: _____
- Bus Address: _____

Configuring the Drive on HP-UX:

1. Log in as root.
2. Run SAM by typing the following:

```
$ /usr/bin/sam
```
3. Choose **Disks and File Systems->**.
4. Choose **CD-ROM, Floppy, and Hard Disks**.
5. From the **Actions** menubar in the "Disk and File System Manager" window, highlight and choose **Add a Hard Disk Drive...**
6. Within the "Add a Hard Disk Drive" window, choose **Select Disk to Add**.
7. Within the **Select a Disk to Add** window, highlight the line identifying the new drive you have just connected. It will be described as, for example,

“CD ROM-SCSI”, followed by its model number and bus address. Activate **OK**.

If the device you have connected does *not* appear on the list:

- a. Check your hardware connections, and make sure that the device is turned *on* and that there is a disc in it.
- b. Activate the button **Device Missing**, and you will be given the following options:
 - i. Have SAM rescan the system for the device. If you have connected the device *after* starting SAM, you should activate **Yes**. Otherwise, activate **No**.
 - ii. Respond to the confirmation screen regarding whether the device is connected and powered up.
 - iii. Respond to the confirmation screen regarding whether additional device drivers are needed.
 - iv. You will be given an information screen suggesting things to try if the device still cannot be found. If this is the case, you will need to consult *Installing Peripherals*.
8. If you need to add drivers to the kernel, SAM will prompt you for doing so and will ask whether you wish to recreate the kernel now or later. Make this selection by pressing **(Return)** when your selection is highlighted. Then the selection is designated by an asterisk (*) in its blank. Activate **OK** to enter that selection.
9. **Set Disk Usage and Options**. (File system usage is already set for a CD ROM.) Enter the mount directory where you want the CD ROM to be.
10. **Modify Defaults...**. (This task is optional). You may want to change certain options, such as when to mount the disk and how its access permissions are set. If so, within the **Add a Hard Disk Drive** window, highlight and activate **Modify Defaults**. Then, within the dialog box, select or modify the options that apply.
11. Activate **OK** when you have finished with the main **Add a Hard Disk Drive** form.

6-20 Configuring HP-UX for Printers and Drives

12. A “Messages” Box appears, reporting the progress of the task. When the task is finished, activate **OK**.
13. Exit SAM by returning to opening screen and activating **Exit SAM**.

Testing Your Installation

A simple test to make certain that everything has been installed correctly is to execute the command `diskinfo`.

1. First make sure a CD ROM is inserted in the drive.
2. Then, type the following (using the appropriate device file name as the argument). For example:

```
diskinfo /dev/rdisk/2s0
```

If the disk is installed correctly, `diskinfo` will display a listing of information about it, such as the following:

```
2s0
SCSI describe of /dev/rdisk/2s0
    vendor: TOSHIBA
    product id: CD-ROM DRIVE:XM
    type: CD-ROM
    size: nnnnnn Kbytes
bytes per sector: 2048
```

6

Mounting the New CD ROM Drive

SAM will mount the disc for you when you install the drive. You can then mount it and unmount it manually, using the `mount` and `umount` commands, as with a flexible disk.

If you have not already had SAM do so, in order for your system to boot with the new CD ROM mounted, you will need to edit your `/etc/checklist`. Add the following line to the `/etc/checklist` file:

```
/dev/dsk/2s0 /cdrom cdfs ro 0 0 # CD ROM
```

If you have only made this change to your system, executing `mount -a` will mount the new disk automatically, and it will stay mounted until you unmount

it manually. (Note that using the `-a` option mounts *all* unmounted devices in `/etc/checklist`.)

After mounting a new disk on a directory, an `ll` listing of the directory should give you at least one file or directory entry. For example:

```
total 1024
drwxr-xr-x  2 root    root      8192 Aug 31 15:24 filename
```

See the next section for information on unmounting the disc before you remove it.

Removing and Inserting a Disc

You must mount a CD ROM disc every time you insert it into the drive, and you must unmount the disc before the system will allow you to eject it from the drive.

Note The eject button on the CD ROM drive is disabled while the device is mounted or in use.

■ Before you remove a disc:

1. For example, if the disc is designated by the block device file `/dev/dsk/2s0`, temporarily unmount the disk's file system by executing the following:

```
umount /dev/dsk/2s0
```

2. Press the eject button to remove the disk

■ After you insert a disk:

1. Mount the CD ROM file system so that HP-UX will recognize it. If, for example, you are mounting the CD ROM designated by the device filename `/dev/dsk/2s0`, create a directory `/cdrom` (if it doesn't exist already) and execute the following:

```
mount /dev/dsk/2s0 /cdrom
```

(Note that the directory `/cdrom`, in the example, must be given as an absolute path name).

In this example, the `mount` command announces to the system that a removable file system is to be attached at the directory `/cdrom`. This directory becomes the name of the root of the newly-mounted file system.

2. Now you can access the CD ROM as you would any other disk, except that you cannot write to it.
3. A flashing busy light indicates normal activity with the system.

For More Information

- For more information on the `mount`, `umount`, and `reboot` commands, please see the appropriate entries in *HP-UX Reference*. You can also use your online command help system by typing `man`, followed by the name of the command, and `(Return)`.
- Information on the installation of external peripheral devices can be found in *Installing Peripherals*.

Configuring for a DDS Tape Drive

This section contains instructions for configuring a new DDS drive on HP-UX.

The DDS (“Digital Data Storage”) Tape Drive is a sequential-access, read-write device using removable DDS cassettes. Although DDS drives are similar to DAT players in the audio industry, the cassettes are *not* interchangeable. There are two major differences:

1. Audio cassette tapes transfer data in streaming mode. That is, they are left in motion for periods of minutes. Tapes used for data are continually starting, stopping and repositioning, which is stressful to the tape. DDS tapes are made rugged enough to stand this kind of treatment. Audio tapes are not expected to perform this well, and as a result fail very quickly in a data environment.
2. DDS cassettes have a much tighter case dimension specification than DAT cassettes. As a result, DAT cassettes can get stuck in a DDS drive, requiring the drive to be disassembled. For this reason, only Hewlett-Packard supported or properly certified DDS tape cartridges should be used. Use of DAT tapes intended for audio use could void your warranty.

Caution Do not attempt to extricate a DAT cassette which is stuck in a DDS drive. You may damage the drive. Have the drive disassembled by someone qualified to do so.

The steps for adding a DDS tape drive to your system are:

1. Make sure that the necessary device drivers are configured into the kernel. SAM will make this test.
2. Choose a SCSI bus address for the new tape drive that does not match the bus address for any other SCSI device.
3. Shut your system down and turn off the power.
4. Make all necessary hardware connections for the device.
5. Turn the new tape drive *on*.
6. Turn your system *on*.
7. Run SAM to create the device files for the new tape drive.

The factory-set SCSI address for the DDS drive:

- For an upgrade drive: SCSI bus address: 3

As it is possible that the SCSI bus address jumpers for an upgrade may be shipped with different settings, please check the settings before installing the device. See the *Installation Guide* for the device for information on resetting it, should it be necessary.

6

Configuring the Drive on HP-UX

The SAM `Peripherals Devices` → `Tape Drives` procedure will confirm which drivers are active for your tape devices and will configure them as needed, for connected devices. Reconfiguring the kernel will involve rebooting your system.

Before You Begin:

First make a note of the tape drive model and its hardware address (SCSI bus address) so that you will be able to identify it later.

■ DDS Drive Model: _____

■ Bus Address: _____

1. Log in as `root`.
2. Run SAM by typing the following:

```
$ /usr/bin/sam
```

To get help in SAM, pressing the `f1` key gives you context-sensitive information for the object at the location of the cursor.

3. Highlight and select `Peripheral Devices ->`
4. At the next screen highlight and select `Tape Drives ->`
5. The `Tape Drive Manager` screen lists what tape devices are connected, including your new device. Highlight that device.
6. From the `Actions` menu, choose `Add...`. A message screen gives you the hardware steps for adding the tape drive. Activate `OK`.
7. A confirmation screen indicates whether any related device drivers needed to be added to the kernel. Activate `Yes` or press `Return`.
8. If you needed to add a device driver, you will also need to create a new kernel and (eventually) reboot the system. Select from the menu on the `Create a New Kernel` screen whether you want to create the new kernel now, later, or cancel the proposed modifications. (Make sure your choice has an asterisk placed by it, by pressing `Return` while that line is highlighted.) Activate `OK` to confirm your choice of action.
9. You will next be given a choice of whether to install the new kernel now or later. If you move the kernel into place now, the system will also reboot. If you choose to do it later, you can then move the new kernel, `/etc/conf/dfile.SAM` to `/hp-ux` and reboot. You should also move `/etc/conf/dfile.SAM` to `/etc/conf/dfile` at the same time.

6-26 Configuring HP-UX for Printers and Drives

If you reboot, the old kernel will be backed up as `/SYSBCKUP`.

10. Exit SAM, if you have not already done so.

Note If you are modifying a cluster client's kernel, its kernel is not backed up, since `/SYSBCKUP` is used exclusively for the cluster server's kernel.

Your system is now running the added driver for SCSI DDS tape drive. You are ready to use the drive to load a tape into your system.

Testing Your Installation

Note that a write-protect tab on the cassette allows you to protect data from being over-written. You will need to make sure that the tab is moved to the "writable" position in order for it to serve as a back up medium.

A simple test to make certain that everything has been installed satisfactorily is to load a tape in the drive, wait for the "busy" light to stop blinking, and execute the `ioscan` command:

```
/etc/ioscan
```

The LED on the drive should flicker briefly. If the command completes successfully, a listing of your devices, including the tape hardware address, name and status will be displayed, indicating that it is installed correctly. Note that the command may fail with a busy error if the command is executed before the tape has completed loading.

6



DDS Tape Drive LED Indicators

Two LED indicators on the drive's front panel indicate several operational and test states. The following tables show the LED combinations and explain what they indicate.

DDS Tape Drive LED Symbols Used in Table 6-1







LED Symbol	Meaning
	Off
	Green
	Amber
	Pulse Green
	Pulse Amber
	Pulse Green/Amber

Table 6-1. DDS Tape Drive LED State Codes

States	Cassette	Drive	Meaning
Read/Write			Cassette (un)loading
			Cassette loaded/online
			Cassette loaded/Activity
			Cassette loaded/offline
Write-Protect			Cassette (un)loading
			Cassette loaded/online
			Cassette loaded/Activity
			Cassette loaded/offline
Error			Media wear (Caution Indicator)
			High humidity/No termination on SCSI bus
			Self-test (normal)
			Self-test (failure)

Caution Indicator

The DDS drive continually monitors the number of errors it has to correct when reading or writing a tape. This information is presented to the user through the Caution Indicator (see above chart).

A caution indication has two common meanings:

- The tape heads need cleaning.
- The tape itself is approaching the end of its useful life.

Maximum Usage of DDS Cassettes

Under optimal environmental conditions (50% relative humidity, 22°C), Hewlett-Packard DDS cassettes are currently specified to 2000 passes over any part of the tape. In operational terms, this can be translated into approximately 200 to 300 backup operations. This takes into account that, during a backup, an area of tape may have several passes because streaming cannot be maintained, or because the backup software requires that certain areas of the tape are accessed frequently.

Under certain conditions, the recommended number of backup operations needs to be reduced. These conditions are as follows:

- Sustained use at low humidity.
- Use in a low-performance workstation, requiring an increased number of passes.
- Backup software requiring certain areas of the tape being accessed frequently.

As a guideline, HP recommends that the number of backup operations should be limited to 100 per cassette in extreme cases of the above conditions.

6

In Case of Difficulty

If you experience any problems with the operation of the new drive, contact your HP service representative for assistance.

Dealing with Problems

Chapter Contents

- Interpreting Error Messages During Boot.
- Interpreting the LED Indicators.
- Dealing with HP VUE Problems.
- Re-Setting the VRX Special Device Files with mknod.
- Managing a Boot Failure.
- Recovering from a System Panic.
- Dealing with Network Failures.

Interpreting Error Messages During Boot

When you turn on your controller, an error message such as the following indicates that a hardware problem with the Boot ROM or its associated circuits occurred:

Configuration EEPROM Failed

Configure Mode Failed

Refer to Table 7-1 for possible error messages you may see when entering Configuration Mode.

Table 7-1. Configuration Mode Entry Error Messages

Error Message	Meaning and Action
(No error message)	If Configuration Mode does not start and no error message appears, a hardware failure probably occurred.
Configure Mode Failed Configuration EEPROM Failed	One or more of these situations exists: All of the interface values have been set to their default (factory) values. Some default and some changed values have been set. All the interface values have been set to their changed values. Some minor error occurred that should not affect the configurations for the interface. Check the Boot Mode Selection and Interface Configuration Modes for your controller and verify they are correct for your application.
EEPROM Has Bad Information	Configuration Mode started, main menu may appear, but something failed. Try again.

7-2 Dealing with Problems

Table 7-1. Configuration Mode Entry Error Messages (continued)

Error Message	Meaning and Action
EEPROM Load Section Missing	Could not load new configuration data. Hardware failure.
EEPROM Defaults Section Missing	Default configurations could not be found. Hardware failure.
Too much data to save	Too many interfaces for EEPROM to manage. Reconfigure controller with fewer interfaces.

If the Boot ROM or EEPROM has problems after you enter one of the configuration commands (also see Appendix A), the mode lines display one of the error messages shown in the following table.

Table 7-2. Configuration Mode Exit Error Messages

Command	Error Message	Meaning and Action
<i>N</i> or <i>D</i>	Too many configuration saves	More than 64,000 saves were tried. Unlikely to occur.
<i>N</i> or <i>D</i>	Cannot save new configuration	Something prevented saving the new configuration. Hardware failure. Contact your HP Service Engineer.
<i>N</i> or <i>D</i>	EEPROM cannot save information	EEPROM may not save any or all of the new configuration information. Hardware failure. Contact your HP Service Engineer.
<i>A</i>	(No message should appear)	No error messages should appear when you abort configuration mode and reset your controller.

Interpreting the LED Indicators

There are eight diagnostic LEDs on the system board, which you can view through a slot on the rear panel.

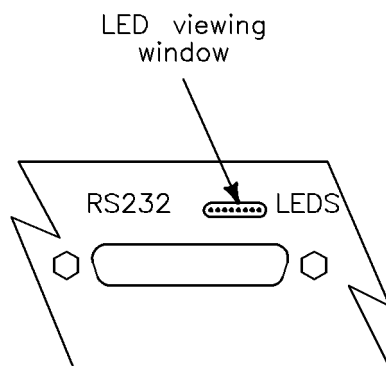

Figure 7-1. Rear Panel Viewing Slot for Diagnostic LEDs

These give normal indications for HP-UX when it is running, as shown in Table 7-3. Some of these LEDs will always be blinking during normal operation.

Table 7-3. Normal LED Display During HP-UX Operation

LED Display (A through D Flashing)								Meaning
A	B	C	D	E	F	G	H	
○	○	○	●	○	○	○	○	Operating system running
○	○	●	○	○	○	○	○	Disk access in progress
○	●	○	○	○	○	○	○	Network receive in progress
●	○	○	○	○	○	○	○	Network transmit in progress

7

7-4 Dealing with Problems

The indications in Table 7-4 refer to conditions which might happen during boot, including boot failures, *before* HP-UX is running:

Table 7-4. Diagnostic LED Display During Boot

LED Display (During Boot)	Status	Remedy
A B C D E F G H		
○ ○ ○ ○ ○ ○ ○ ○	No failure.	
○ ○ ○ ○ ○ ○ ○ ●	Failed CPU register test.	Replace CPU board.
○ ○ ○ ○ ○ ○ ● ○	Testing the top 16 Kbyte of memory.	
○ ○ ○ ○ ○ ○ ● ●	Top 16 Kbyte of memory failed.	
○ ○ ○ ○ ○ ● ○ ○	Top 16 Kbyte of memory missing or not found.	Check memory in slot 0 and 1.
○ ○ ○ ○ ○ ● ○ ●	Searching for user-supplied extension ROM.	
○ ○ ○ ○ ○ ● ● ○	Started executing extension ROM instructions.	
○ ○ ○ ○ ○ ● ● ●	Starting test vector list.	
○ ○ ○ ○ ● ○ ○ ○	Resetting all interfaces.	
○ ○ ○ ○ ● ○ ○ ●	Searching for console display.	



Table 7-4. Diagnostic LED Display During Boot (continued)

LED Display (During Boot)	Status	Remedy
○ ○ ○ ○ ● ○ ● ○	IODC test RAM under test.	
○ ○ ○ ○ ● ● ○ ●	Console failure.	Replace CPU board.
○ ○ ○ ○ ● ● ● ○	Failed Boot ROM checksum.	Replace CPU board.
○ ○ ○ ○ ● ● ● ●	Preloading memory for main test.	
○ ○ ○ ● ○ ○ ○ ○	Testing memory.	
○ ○ ○ ● ○ ○ ○ ●	Insufficient memory.	Replace slot 0 and 1 memory module.
○ ○ ○ ● ○ ○ ● ○	ROM system failure.	Replace ROM system.
○ ○ ○ ● ○ ○ ● ●	Boot error.	Replace CPU board.
○ ○ ○ ● ○ ● ○ ○	Operating system tried to load at too high memory address.	Try booting again, or replace CPU or 68040 IC.
○ ○ ○ ● ○ ● ○ ●	Not enough memory to load operating system.	Add more memory.
○ ○ ○ ● ○ ● ● ○	Failure during system scan.	
○ ○ ● ○ ○ ○ ○ ○	4 msec. timer problem.	Replace CPU board.
○ ○ ● ○ ○ ○ ○ ●	EEPROM malformed.	
○ ○ ● ○ ○ ○ ● ○	Failure of HP-HIL circuit.	Replace CPU board.
○ ○ ● ○ ○ ● ○ ○	Failure of HP-IB circuit.	Replace CPU board.
○ ○ ● ○ ● ○ ○ ○	Failure of DMA circuit.	Replace CPU board.
○ ● ○ ○ ○ ○ ○ ○	Failure of DIO-I interface at select code identified by five lowest LEDs.	Replace CPU board.



7-6 Dealing with Problems

Dealing with HP VUE Problems

If you activate HP VUE and experience any problems, it is probable that one of the following is the source of the difficulty.

If no HP VUE login screen appears:

- Log in on your system console, if possible.
- Start “Doctor VUE” by entering the following:

```
/usr/contrib/bin/X11/dr_vue | more
```

- Examine the displayed output from `dr_vue`. It detects errors in various configuration files.

There are several reasons that HP VUE might fail to start:

- The fileset containing HP VUE is not installed properly.
- The file that controls system startup, `/etc/inittab`, may not be configured properly.
- The X server has not started properly. The X server is specified in the file `/usr/vue/config/Xservers`.

Logging In With HP VUE When All Else Fails

1. Select **Options**.
2. Choose **Fail-safe Session**.
3. Select (highlight) the **Login** box.
4. Type your login name.
5. Press **Return**.
6. Type your password.
7. Press **Return** or activate **OK**.

When you log into a fail-safe session, a window appears with a command-line prompt in it, giving enough of an environment so that you can use the command line to remedy problems or edit faulty configuration files.

See the *HP VUE User's Guide* for more information.

Re-Setting the VRX Special Device Files with mknod

The special device file for the internal VRX graphics hardware used in the Model 382 should already be set up correctly as `/dev/crt` by the system boot code. If `/dev/crt` does not exist, is deleted for some reason, or does not allow the device driver access to the hardware, use the information below to create a new `/dev/crt`.

The `mknod` command creates a special device file which is used to communicate between the SPU and the internal graphics. Superuser status is required to set up special device files. See the *HP-UX Reference*, section 1M, for more information on the `mknod` command.

The correct `mknod` command syntax to create a DIO II bus special device file for the internal Entry Level VRX graphics hardware is:

```
mknod /dev/crt c 12 0x840300
      ^ ^      ^ ^ ^
      | |      | | +--> 00 = (Used by Starbase)
      | |      | +---> 03 = SGC-type card
      | |      +-----> 84 = SGC slot number (=DIO SC 132)
      | +-----> 12 = Graphics device
      +-----> c = Character based device
```

Managing a Boot Failure

The boot program is located in the Boot ROM of your controller.

Here are some things to check if something has gone wrong at this point in the boot process:

1. Boot Program Initializes Hardware

Problems during this first stage of the boot process are rare. At this stage problems can be caused by:

- No power to the controller (check your building's circuit breakers and the power connections to your controller equipment)
- Processor hardware failure
- Interface card hardware failure
- Incorrectly connected internal SCSI cable.

Turn off the power to the controller (leave any external disks powered up and running). Wait five or ten seconds and turn the power to the controller back on.

If the problem reoccurs, record the symptoms, the status of any indicators (especially any LED displays) on your processor, and any messages that appear on your system console.

7

At this stage in the boot process, most of the problems that occur require your hardware to be serviced by a person trained and qualified to do so.

2. Boot Program Loads a Secondary Loader Program

In this step the boot program attempts to load and run a secondary loader program that will be capable of loading and running HP-UX. The most likely problem at this stage is the boot program being unable to locate the secondary loader program.

If the boot program can't locate a secondary loader, you will see the message "Searching For a System" in the lower left corner of your display. Verify that at least one device is powered on and in a ready state (it must also have a Secondary Loader Program, of course).

7-10 Dealing with Problems

This symptom could also indicate that no kernel was found (see the next phase for details).

3. Boot Program finds the WRONG secondary loader

Another possible problem at this stage is that the boot program *does* find a secondary loader program, but the one it finds is the wrong one.

On the Model 382, there is a particular sequence the boot program uses to locate a secondary loader program. The boot program will use the first one it finds, and it may find one before it reaches the one you want it to use. It may also attempt to boot from invalid disks which were laid out using `newfs` without the `-n` option. (See Appendix A for the procedure for setting up automatic operating system selection.)

If you are booting from a LAN where more than one valid cluster server exists, the *first* server to respond is the one that your system will boot from. It may be unpredictable which server will respond first. Moreover, the one that responds may not be the one you want.

For a server to respond to a boot request from your system, it must have your controller configured in its `/etc/clusterconf` file. Therefore, unless your configuration requires multiple operating systems, you should never have more than one server on your LAN with *your* system defined in its `/etc/clusterconf` file.

4. Secondary Loader Program Loads HP-UX

At this stage, the secondary loader program attempts to load and start up HP-UX itself. There are two things that can go wrong:

1. The secondary loader program can't find HP-UX
2. The secondary loader program loads the wrong version of HP-UX

5. Secondary Loader Program can't find HP-UX

The secondary loader program will display a list of the valid kernels that it finds. When it begins its search for these kernels, it prints the message "Searching For a System". If it doesn't find any valid kernels, nothing further will be displayed.

If after a few minutes, nothing appears to happen, your system probably can't find a kernel to boot. If you're certain that a valid kernel resides on one of your devices, re-check the status of the device (see the following list "Possible Problem Areas").

If you are attempting to boot from a local device such as a disk drive, and if the device is turned on and configured properly, your kernel file may be missing or corrupted. If you have another system to which you can attach the disk drive, you can mount the file system to that system and check for the presence of a valid kernel. If you cannot find one or if you do not have another system to mount your disk on, you can re-install HP-UX following the original installation procedures.

Boot Device Problems

The following are possible boot device problems which could cause boot failure:

- The device is not powered on and in a ready state.
- The device is not configured for the correct address (such as an HP-IB address).
- The cable connecting the device to the controller is incorrect or not tightly connected to the correct location.

If you are attempting to boot an HP-UX client over a LAN, check the following:

- The cluster server is running.
- The `rbootd` daemon is running on the server.
- The cluster server has your controller configured in its `/etc/clusterconf` file.
- The LANIC i.d. field in `/etc/clusterconf` matches the LAN i.d. found by the Boot ROM.
- The file `/hp-ux` is a Context Dependent File (CDF). Also, be sure there is an element in the CDF that corresponds to the client you're trying to boot.

7-12 Dealing with Problems

For More Information

If you need more detail on booting or reconfiguring your system, please see *System Administration Tasks* or *Solving HP-UX Problems*.

Recovering from a System Panic

In HP-UX terms, a system panic simply means that the operating system encountered a condition that it did not know how to respond to, so it halted your controller.

System panics are rare and not always the result of a catastrophe. They sometimes occur at boot if your system was previously not shut down properly. Sometimes they occur as the result of a hardware failure. In a clustered environment, a diskless client node will panic if too much time has elapsed since its last communication with its server. This could be the result of nothing more than a LAN cable that has been disconnected for too long.

Recovering from a system panic can be as simple as rebooting your system. If you have an up-to-date set of file system backup or system recovery tapes, the *worst case* scenario would involve reinstalling HP-UX and restoring any files that were lost or corrupted. If this situation was caused by a rare hardware failure such as a disk head crash, you will, of course, have to have the hardware fixed before you can perform the reinstallation.

Note

It is important to maintain an up-to-date backup of the files on your system so that, in the event of a disk head crash or similar situation, you can recover your data. How frequently you update these backups depends on how much data you can afford to lose. For information on how to back up data, refer to *System Administration Tasks*.

Should your system have this problem, it is important to record and categorize the circumstances associated with the panic:

Summary Checklist of Possible Causes of Panics

Problem Area	Some Corrective Actions:
Hardware	<ul style="list-style-type: none"> ■ If the failure appears to be associated with the peripheral: <ul style="list-style-type: none"> □ Check the integrity of the cable connections. □ Ensure that the peripheral is online. ■ If the above did not correct the problem, the failure may be associated with the System Processing Unit. In this case, call your designated service representative.
File System	<ul style="list-style-type: none"> ■ Run the file system checker, fsck, to correct the problem. Follow the instructions that fsck may give, and use the -n option with any subsequent reboots required by fsck. See Chapter 6 “File System Problems,” in <i>Solving HP-UX Problems</i> for detailed information.
LAN	<ul style="list-style-type: none"> ■ Ensure the integrity of all LAN connections, including taps in any AUI cable. Check for proper 50 ohm terminations at both ends of the LAN.
Other	<ul style="list-style-type: none"> ■ Reboot the system



Procedures for Recovering from a System Panic

Step 1: Note the Panic Message

Record the panic message displayed on the system console.

Step 2: Categorize the Panic Message

The panic message will tell you why HP-UX panicked. Sometimes panic messages refer to internal structures of HP-UX (or its file systems) and the cause might not be obvious. Generally, the problem is in one of the following categories, and wording of the message should allow you to classify it into one of them:

Category	Action Step Number
Hardware Failure	Step 3a
File System Corrupted	Step 3b
LAN Communication Problem	Step 3c
Other Situations	Step 3d

Step 3a: Recovery from Hardware Failure

7

If the panic message indicated a hardware failure, the text or context of the message should indicate what piece of hardware failed.

If the hardware failure appears to be associated with a peripheral, check to be sure that its cables are tightly connected to their proper locations and that the device is powered on and in an “online” state. If there is an error indicated on the device’s display:

1. Keep a log book and record error messages in it.
2. Turn the device off.
3. If the device is a disk drive, wait for it to stop spinning.
4. Turn the device back on.

7-16 Dealing with Problems

If the problem reappears on the device or if the hardware failure appears to be associated with an interface card or an internal component of the system module, you should refer the problem to your HP service representative.

Proceed to Step 4 (“Rebooting Your System”).

Step 3b: Recovering from a File System Problem

If the panic message indicates a problem with one of your file systems, you will need to run the file system checker *fsck(1m)* to check and correct the problem(s). This is normally done automatically at boot time (from the */etc/rc* file) so you should proceed to step 4 (rebooting your system). Follow all directions that *fsck* gives you *especially if it is your root file system (the one with the “/” directory) that has the problem*. It is important to use the “-n” option to the *reboot(1m)* command if requested to do so by *fsck* during any subsequent reboot.

Step 3c: Recovering from a LAN Communication Problem

If the panic messages indicates a problem with LAN communication (such as when a diskless cluster client node is prevented from communication for too long), check all LAN cable connections to be sure of the following:

- All connectors are tightly fastened to the LAN cable and the media access units (MAU’s).
- LAN is assembled correctly and does not exceed recommended lengths. If you use an AUI, the LAN must be connected *directly* to the MAU with no intervening length of cable between the MAU on your controller to the LAN tee.
- Your LAN is properly terminated.

Proceed to step 4 (rebooting your system).

Step 3d: Recovering from Other Situations

When you suspect the problem was something other than the above (or when you do not know where to classify it), proceed to step 4 “*Rebooting your system*.” In this case, it is *especially* important that you write down the *exact text* of the panic message, just in case you need it for future troubleshooting or help from HP service personnel.

Step 4: Rebooting Your System

Once you have checked for and corrected any problems from Step 3, you are ready to reboot your system. If your system has not gotten past the system selection phase of the boot process, it is safe to turn it off and then back on to initiate the boot sequence.

You will probably notice a few differences in boot behavior as compared with your normal boot sequence. Your controller might have saved a “core” file to disk. This core file is a “snapshot” of the previously running kernel at the time that it panicked. If necessary, this core file can be analyzed using special tools to determine what caused the panic.

Note Core files are quite large and are saved to the directory `/tmp/syscore`. If you feel you need to save these files for future analysis (something that isn’t usually required), it is best to save them to tape and remove them from your file system in order to free up space. If you *know* why your system panicked, you can delete the core files; it is unnecessary to keep them. The core files are used in rare circumstances to diagnose hard-to-find causes of system panics.

If the reason your system panicked was because of a corrupted file system, the `fsck` utility will report the errors and any corrections it makes. If the problems were associated with your root file system, `fsck` will return a message to reboot your system when it is finished. In this case, use the following command:

```
reboot -n
```

The `-n` option tells the `reboot` command *not* to sync the file system before rebooting. Since `fsck` has made all the corrections on disk, you do not want to undo the changes by writing over them with the corrupt memory buffers.

Step 5: Monitor the system closely

If your system successfully boots, you can resume normal operations. Many system panics are isolated events and are unlikely to reoccur.

7-18 Dealing with Problems

Check your applications to be sure that they are running properly and monitor the system closely. You should also do backups more frequently until you are confident that the system is functioning properly.

For Further Information . . .

- See *Solving HP-UX Problems* and *System Administration Tasks* for further information on problems relating to the operating system.
- To restore a corrupted operating system, see the procedures for restoring in Chapter 5 of this manual.

Dealing with Network Failures

If the program you have been running uses resources from a local area network and it stops unexpectedly, the following may help locate the source of the problem:

Table 7-5. Problems with the Network

Problem	Action
No systems respond to the <code>/etc/ping hostname</code> command.	Check the network connection at the back of your workstation. Make sure that the cable is securely fastened to the appropriate connector.
Your system does not respond to <code>/etc/ping</code> from another system on the network.	Check to see if the networking software is still running on your system. If it is not running, restart it by logging onto your system as superuser and running <code>/etc/rc</code> .
Some systems respond to <code>/etc/ping</code> , but others do not.	Contact your network administrator, if you have one. This condition either indicates that some systems are down, or that there is a fault with the network.

A

Configuring the Boot ROM

Appendix Contents

- Using the Boot ROM Configuration Mode for HP-UX
- Configuring for Automatic Operating System Selection

Using the Boot ROM Configuration Mode

The Boot ROM configuration mode is used for internal interface configurations or Auto System Selection for your controller.

Configure Mode is run and controlled by the Boot ROM. You do not need to have an operating system installed to use Configure Mode.

If the operating system is installed and you want to enter Configure Mode, you must prevent the operating system from booting. Instructions are provided in this chapter.

1 Turning on your monitor and your controller. The power-up display will appear.

2 If your HP-UX operating system has been installed, you must prevent the operating system from booting shortly after turning your controller on. As soon as the following line appears in your power-up display press the **space bar** to prevent HP-UX from booting:

... *(You will hear a double-beep)*

HP-HIL.Keyboard

...

You will still see the power-up display, but HP-UX will not boot.

3 With the power-up display shown on your monitor, press these keys to enter Configuration Mode:

C **Return**

A-2 Configuring the Boot ROM

- 4** You should see this menu appear in the upper right-hand corner of the power-up display:

```
Configuration Control
Keys      Control Class
-----
1 I/O Configuration
2 Auto System Selection

A Abort without changes
-----
Type [key] RETURN ?
```

The ? prompt below the menu indicates your controller is waiting for an input. To respond, press an appropriate number or letter key, followed by **Return**.

If you now want to change the I/O configuration of your controller, go on to the next section.

If you want to leave Configuration Control without making any changes, enter "A" followed by **Return**. The system will reset and run the power-up self test.

Modifying I/O Configuration Information

Configuration settings are stored in a part of memory called an EEPROM (“Electronically-Erasable Programmable Read-Only Memory”). Information stored in the EEPROM remains intact even when your controller is turned off.

Table A-1 lists the factory-set default configurations for your EEPROM.

Table A-1. Built-In Interface Default Values

Built-In Interface	Function	Default Configuration	Options
SCSI	Select Code	14	0 to 31
	Interrupt Level	4	3 to 6
	Bus Address	7	0 to 7
	Parity	Yes	Yes/No
LAN	Select Code	21	0 to 31
	Interrupt Level	5	3 to 6
HP Parallel	Select Code	12	0 to 31
	Interrupt Level	3	3 to 6
HP-IB	System-Controller option	yes	yes/no
RS232	Select Code	9	0 to 31
	interrupt level	5	3 to 6
	Remote/Local	L	R or L
	Modem Enable	yes	yes/no

Follow these instructions to enter and use I/O Configuration Menu.

Enter the following:

1

A-4 Configuring the Boot ROM

This Configurable Interfaces menu replaces the Configuration Control menu:

```

Configurable Interfaces
Keys  Interface Select Code
-----
 1   LAN                21
 2   HP-IB              14
 3   SCSI                12
 4   HP Parallel        9
 5   RS-232

N store New values
D store Default values
(then cycle SPU power)
A Abort without changes
-----
Type [key] RETURN ?

```

Each of the three commands is explained below.

Possible Response	Function and Meaning
(N)	Stores all the listed new values you entered in the EEPROM. You can turn off your controller, and then turn it back on, and the new values will be used. The system resets and runs the power-up self test.
(D)	Exits the Configuration Mode and stores the factory default values in the EEPROM. You must cycle controller power to reconfigure the interfaces to these default values.
(A)	Causes the Boot ROM to reset and run the power-up self-test without saving any changes you may have made to the interface values. The pre-existing values will be used.

Enter your response followed by (Return) after the ? prompt.

If you decide to use the default configurations, exit the menu by pressing D followed by (Return).

Configuring for Automatic Operating System Selection

You will probably want to leave this feature in its default setting unless any of the following applies:

- Two or more operating systems are available on your controller
- Your workstation is connected to a network that contains multiple servers.
- You need to be able to auto boot from a different operating system from that used by other nodes.

If any of these conditions is true, follow these steps to enter and use Auto System Selection:

- 1** With Configuration Control menu in the upper-right corner of the screen, enter
2 **(Return)**.

```

Configuration Control
Keys      Control Class
-----
 1 I/O Configuration
 2 Auto System Selection

A Abort without changes
-----
Type [key] RETURN ?

```

- 2** This menu appears:

```

Auto System Selection
Keys Option          Status
-----
 1 Scan for System   Y
 2 Selected System   N
 3 Store Selected Sys. N

E Execute
A Abort without changes
-----
Type [key] RETURN ?

```

- 3** The prompt ? indicates that your controller is waiting for a letter or number input.

The Auto System Selection menu indicates the way your system is currently set. Toggling the “Status” options by entering one of the numbers under “Keys” on the left will result in a new configuration which will be executed as soon as you press **E**. At that point the system resets and runs the power-up self test.

For example, if your disks contain more than one operating system, you could choose one as the Selected System by pressing 2, followed by **(Return)**.

- 4** The Auto System Selection menu changes to indicate **Selected System**, **Scan for System**, and **Store Selected Sys.** are all Y (“yes”).

```

      Auto System Selection
Keys Option          Status
-----
  1 Scan for System   Y
  2 Selected System   Y
  3 Store Selected Sys. Y

  E Execute
  A Abort without changes
-----
Type [key] RETURN ?

```

- 5** To execute the menu as it appears in the previous step, press **E**, followed by **(Return)**. The system will give you the opportunity to identify the “Selected System” in the next step.

If you decide *not* to change the Auto System Selection configuration, press **A** to leave the configuration unchanged. The system resets and runs the power-up self test.

- 6** If you pressed **E**, the system resets and runs the power-up self test. Your power-up display will change, and the available operating systems would be listed in the upper right-hand corner like this:

```

Copyright 1991                               :(device, select code/address, unit)
Hewlett-Packard Company                       1H SYSTEM_HPUX
All Rights Reserved                           (other systems)

BOOTROM Rev. 3.01 2 MAY 91
MC68040 Processor
Configuration EEPROM
HP-HLL.Keyboard

```

A-8 Configuring the Boot ROM

7 The number-letter designation for the operating system you will select is **1H**.

Enter that prefix by typing **1H** **(Return)**. That operating system will boot.

If you do not enter this information, the Boot ROM will designate the first system it scans as the “Selected System”.

If you previously set the **Store Selected Sys.** option to “yes,” the operating system selected will be the one to automatically boot each time you turn on your controller.

This completes the selection process, and the system will now proceed with booting the selected system for this and future sessions.

For More Information

See “Interpreting Error Messages During Boot” Chapter 7 for additional guidance if you experience problems during this process.

Glossary

absolute path name

The name of a file which lists all the directories leading to it, starting with root (“/”) and ending with the file base name itself. If the path name indicates a *directory*, leave the trailing slash. For example, `/users/jth/`.

access permissions

File name characteristics (including *read*, *write*, and *execute*) which determine whether a process can perform a requested operation on the file (such as opening a file for writing). Access permissions can be changed by a `chmod(1)` command.

activate

In SAM or HP VUE, to cause a graphical control, such as `OK` to take effect by clicking the mouse while the pointer is over that control, or, on a character terminal, by illuminating the control (using arrow keys, etc.) and pressing `Return`.

active window

The window in which keyboard input appears. Only one window can be active at a time. The active window is said to have the keyboard focus.

application

A program used to perform a particular task, usually interactively, such as computer-aided design, text editing, or accounting.

argument

The part of a command line which identifies what (file, directory, etc.) is to be acted upon.

Glossary

ARPA/Berkeley host name

A system name assigned to each system that supports ARPA services.

ASCII

American Symbolic Code for Information Interchange

background process

A program, usually low priority, run non-interactively by the shell without terminal I/O, while other processing occupies the terminal. The “&” at the end of a command line causes that command to be run as a background process.

backup

A copy of all or part of the file system.

bit

BIInary digiT

boot

To start or activate a system.

boot ROM

A read-only memory which is incorporated into a terminal for the purpose starting the operating system, testing the terminal, and producing a standard display.

Bourne Shell

A command interpreter, invoked as `/bin/sh`. The Bourne Shell is the default shell in HP-UX.

BSD

Berkeley Software Distribution.

bus address

A number which makes up part of the address HP-UX uses to locate a particular device. The **bus address** is determined by a switch setting on a peripheral device which allows the computer to distinguish between two devices connected to the same interface.

Glossary-2

button

A graphic element in a display that functionally represents an actual push button. It is usually accessible by mouse pointer and is used to start an action.

C

A standardized and highly-portable computer language. Also the name of the NLS default language/environment (formerly n-computer). Also the name of one of the HP-UX command interpreters, the C Shell (`cs`).

CD-ROM

Compact Disc Read-Only Memory.

CD ROM file system

A read-only memory file system on compact disk. Typically, you can read data from a CD ROM file system, but you cannot write to one.

character

An element used for the organization, control, or representation of text. Characters include graphic characters and control characters.

choose

In HP VUE or SAM, to cause a selection to take effect, by clicking on it twice or by pressing return with the selection illuminated.

click

To press *and release* a mouse button rapidly.

cluster

A group of workstations connected via a LAN. One computer, the **cluster server**, performs as a file-system server for the **cluster clients**. (For information on clusters, see *Managing Clusters of HP9000 Computers: Sharing the HP-UX Filing System*).

cluster client

A cluster node that does not have a local HP-UX file system. Its file system resides on the cluster server. However for HP-UX 8.0, cluster clients can have locally mounted disks for local data storage.

A **client** can also refer to any process run by a server.

Glossary

cluster node

Any workstation networked into an HP-UX cluster. (Also called “cnode”.)

cluster server

The cluster node which acts as a file system server and operating system server for all the cluster nodes in an HP-UX cluster. Also called **cluster root server**.

cnode

Abbreviation for **cluster node**.

CPU

Central Processing Unit. The instruction-processing module of the computer. *See also* **SPU**.

cron

A process which executes commands at specified dates and times.

C Shell

An HP-UX command interpreter, invoked as **cs**.

current session

The HP-UX or HP VUE session to which you are logged in at a particular time.

current working directory

The directory in which relative path name searches begin. It is also called the “current directory” or “working directory”, and is identified by entering the command **pwd**.

device file

A file used for the computer to communicate with a device such as a tape drive or a printer.

DDS

Digital Data Storage. HP-supported “DAT” format for data storage.

dialog box

A subwindow of an application used to request information, or to display status or error conditions.

Glossary-4

DIO

Device input/output.

directory

A table of identifiers and references (such as file names) that refer to corresponding files and items of data. Used in a typical HP-UX organizational structure to provide an organizational and logical identity for a given group of files and directories. In HP VUE, a directory is sometimes called a “folder.”

double click

Pressing and releasing a mouse button twice in rapid succession. For HP VUE, “double click” an icon.

drag

Pressing and holding down a mouse button while moving the mouse pointer.

drop

Releasing an icon that has been “dragged” to a new position by release the mouse button.

environment

The set of defined shell variables (some of which are PATH, TERM, SHELL, HOME) that define the conditions under which your commands run. These conditions can include your terminal characteristics, home directory, and default search path.

expander

Interface hardware for additional DIO cards. One or two expander boxes can be stacked on top of a system unit and connected directly to it or to another expander on which it is placed.

file access permissions

File name characteristics (including *read*, *write*, and *execute*) which determine whether a process can perform a requested operation on the file (such as opening a file for writing). Access permissions can be changed by a *chmod(1)* command.

Glossary

File Manager

The HP VUE component that allows you to manipulate your files and directories, or to set the format and behavior of HP VUE.

fileset

Describes a logically-defined, named set of files on an update or installation tape.

file system

The organization of files on a given storage device, possibly including hierarchical directories.

foreground process

The process occupying the currently active terminal I/O, which may be a window. The shell will not return a prompt until a foreground process has finished executing.

Front Panel

The window area of a default HP VUE screen which contains some accessories, such as the clock, and the control buttons for activating various functions of the workspace manager program, such as print, terminal, style manager, and trash.

group

An association of users who are all permitted to access the same set of files. The members of a group are defined in the files `/etc/passwd`, `/etc/group`, and `/etc/logingroup` (if it exists) via a numerical group ID. Users with identical group IDs are members of the same group.

group access list

The group access list is a set of supplementary group IDs, associated with a process, used in determining resource accessibility.

\$HOME

The value of the environment variable representing the **home directory**.

home directory

The directory name given by the value of the shell variable HOME. This is the directory where the user starts after logging in, typically `/users/login`, where *login* is your login name.

Glossary-6

home session

An HP VUE user-configured default session. Unless you specify otherwise, the home session is restored each time you log in.

host name

Refers to a string which uniquely identifies a system in a network. There are generally different **host name** domains associated with different networks.

HP-HIL

Hewlett-Packard Human Interface Link.

HP-IB

Hewlett-Packard Interface Bus (IEEE 488 standard).

HP-UX cluster

A group of workstations connected via a LAN. One computer, the **cluster server**, performs as a file-system server for the **cluster client**. **Cluster** can also be used by itself if the context is clear. "Diskless cluster" should not be used.

HP VUE

HP Visual User Environment.

icon

A miniaturized graphic representation of a window in the workspace (typically an application window). Processes executing in a window continue to execute when the window is iconified.

IEEE

Institute of Electrical and Electronics Engineers, and the interface format which bears its name.

ITE

The Internal Terminal Emulator program, which allows a bit-mapped display to function as a standard computer terminal.

kernel

The part of the HP-UX operating system that is responsible for managing the computer's resources.

Glossary

keysh

The command for invoking a Key Shell.

Key Shell

An HP-UX shell which, as an extension of the Korn Shell, uses hierarchical softkey menus and context-sensitive help to aid users in building command lines. Invoked as `usr/bin/keysh`.

Korn Shell

An HP-UX shell, featuring command history recall and line-editing. Invoked as `/bin/ksh`.

LAN

See **Local Area Network**.

LANG

An NLS environment variable that is used to inform a computer process of the user's requirements for "native language," "local customs," and "coded character set." This variable can be set at login by clicking on the **Options** menu in the HP VUE Login screen.

LED

Light-emitting diode.

Local Area Network

The systems and/or clusters which share data, hardware, and software resources via Networking Services software.

locally-mounted file system

A file system mounted on a disk attached to a cluster client and shared by other nodes in the cluster.

login

Your login name, the name by which you are known to the workstation. This may be any group of characters, so long as it meets system rules.

maximize

The function of enlarging a window to its largest size. OSF/Motif window managers, such as the HP VUE Workspace Manager, provide this function. Also see **minimize** and **restore**.

Glossary-8

menu bar

An area at the top of a window that contains the pull down menus for that application.

minimize

The function of reducing a window to an icon. OSF/Motif window managers—such as the HP VUE Workspace Manager—provide this function. *Also see* **restore**.

mnemonic

A single character used as a keyboard shortcut for a SAM or VUE command. Usually, a command's mnemonic is its initial letter. The screen indicates a mnemonic character by underlining or illuminating the character.

mount

To add an auxiliary (removable) file system to an active existing file system.

mount directory

The directory in an existing file system that is the root directory of a mounted auxiliary file system.

multiuser state

The condition of the HP-UX operating system in which the cluster nodes (and console) allow communication between the system and all its users.

Native Language Support (NLS)

A feature of HP-UX that provides the user with internationalized software and the application programmer with tools to develop this software.

NFS

Network File Services.

NFS file system

A file system accessible over a network via the NFS Services product.

node name

A unique string used to identify each node in a cluster.

Glossary

operating system

The contents of */hp-ux*, including the kernel, commands, input-output control, system accounting, storage assignment, and other services. *Also see kernel.*

OSF

Open Software Foundation.

owner

The owner of a file is usually the creator of that file. However, the ownership of a file can be changed by the superuser or the current owner with the *chown(1)* command or the *chown(2)* system call.

parent process ID

A parent process identification. *Also see PID.*

password

An encrypted sequence of characters used by HP-UX to identify an authorized user and to permit authorized login on a system.

path name

(Two words, except as an italicized argument, *pathname.*)

A sequence of directory names, separated by slashes, which specify the location of any file or directory.

PID

Process identity (number).

pop-up menu

A menu that remains invisible until a user action or some condition in the program causes the menu to display. Typically the user either presses the “menu button” on the mouse (a common default is button 3), or presses the “menu key” on the keyboard (a common default is F10).

POSIX

PORTable Systems Interface (for UN*X). UN*X standard from IEEE.

Posix Shell

POSIX-compliant version of the Korn Shell.

Glossary-10

ppid

Parent process ID.

process

An invocation of a program. Generally, **process** refers to a program running in memory, while **program** is the code stored on disk.

process ID

A unique identification number assigned to all processes by the operating system. *Also see* PID.

pty

Pseudo-terminal.

RAM

random-access memory.

regular expression

A string of characters that selects text.

relative path name

The name of a file, listing all the directories leading to that file in relation to the current working directory.

restore

The function of returning a window to its normal size from a *maximized* or *minimized* state. OSF/Motif window managers, such as the HP VUE Workspace Manager, provide this function.
See **minimize** and **maximize**.

ROM

read-only memory.

root directory

The highest level directory of the hierarchical file system, from which all other files branch. In HP-UX, the slash (/) character refers to the “root directory.” The root directory is the only directory in the file system that is its own “parent directory.”

Glossary

root file system

The file system mounted on the cluster server.

root server

The node in a cluster to which the storage device containing the root file system of the cluster is physically attached. *Also cluster server.*

root user

The user with root permission, having a separate “root” account and password, and working with the Bourne Shell, as the default shell.

run-level

The system state determined at boot which defines, among other things, multi- or single-user status.

SAM

System Administration Manager. A subsystem of HP-UX that helps you to do a wide range of system administration tasks interactively.

script

A file that contains commands that a shell can interpret and run.

scroll bar

In graphical interfaces, a graphical device used to scroll data displayed in a window. A scroll bar consists of a slider, scroll area, and scroll arrows.

SCSI

Small Computer System Interface.

select

In HP VUE or SAM, to illuminate an item in a form or menu by using the mouse pointer and clicking on the item, or, on a character terminal, by moving the illuminated area using the arrow keys, etc.

server

A computer program that provides file access, login access, file transfer, printing and other services across a network. Sometimes, but not always, a server consists of a dedicated computer.

Glossary-12

session

The time between logging in and logging out.

shell

An HP-UX command interpreter (Bourne, Korn, Key, Posix or C), providing a working environment interface for the user. The shell takes command input from the keyboard and interprets it for the operating system.

shell script

A file that contains commands that a shell can interpret and run. Also “shell program.”

shut down

To take the system from multi-user state to a state in which no processes are running, using the **shutdown** command.

single-user state

The state of a computer where there is little or no process activity and no users logged in. The system is only accessible to the current system administrator (root). This mode is brought about by execution of *shutdown(1)*. Also called **single-user mode**.

SPU

System Processing Unit. The instruction-processing module of the computer.

standalone

A computer which is not part of a cluster.

standard error

The destination of error and special messages from a program, intended to be used for diagnostic messages. The standard error output is often called **stderr**, and is automatically opened by the shell for writing on file descriptor 2 for every command invoked. Standard error usually appears on the display unless it is directed otherwise.

standard input

The source of input data for a program. The standard input file is often

Glossary

called `stdin`, and is automatically opened by the shell for reading on file descriptor 0 for every command invoked.

standard output

The destination of output data from a program. The standard output file is often called `stdout`, and is automatically opened by the shell for writing on file descriptor 1 for every command invoked. Standard output appears on the display unless it is redirected otherwise.

SU

Super User. *See* **root user**.

system name

The eight-character (or less) string which uniquely identifies a system. Usually identical with the system's host name found in `/etc/hosts`. The Internet Protocol (IP) number is sometimes used instead of a system name to identify the system.

timeout

Deactivation of a device or system after a pre-set time.

title bar

The rectangular area at the top of a window that contains the title of the window (for example, "Terminal Window" or "File Manager"). In OSF/Motif window managers, such as the HP VUE Workspace Manager, the title bar can also be used with the mouse pointer to move ("drag") the window to a new location.

Also called "menu bar".

Toolbox

A special HP VUE File Manager view for managing applications and other software. Sub-types of toolboxes accessed with the Toolbox slideup panel are: Personal, General, Network, and Marketplace.

tree structure

The HP-UX method of organizing files and directories into a hierarchical structure. This structure looks like an inverted tree with the "root" directory at the top, descending into multiple directory/file branches that end in clusters of files.

Glossary-14

uid

User ID.

user

Any person who interacts directly with a computer system.

user interface

The medium through which users communicate with their workstations. The command-line prompt is one type of interface. The graphical objects of HP VUE are another type of interface.

user ID

An integer which identifies each system user.

VUE

Visual User Environment.

window

A frame-defined, rectangular area of the screen used by the HP VUE to contain a particular application or a command line. Client applications can have multiple windows.

window menu

The menu in the upper-left corner of an HP VUE window frame.

working directory

This is the directory in which relative path name searches begin. It is also called the current directory, or the current working directory.

workspace

The entire area of the display screen when HP VUE starts up. To switch from one workspace to another, you choose the corresponding workspace button in the Front Panel.

workstation

A flexible, graphics-oriented computer, generally high-speed and high-capacity, designed for use in a variety of industrial situations.

Index

3

382 features
 built-in interfaces, 1-3
 general, 1-1
 graphics, 1-3
 hardware architecture, 1-7
 HP-HIL interface, 1-6
 HP Parallel port, 1-6
 HP-UX operating systems, 1-8
 internal mass storage, 1-7
 keyboard, 1-6
 LAN, 1-6
 memory, 1-3
 RS-232 interface, 1-6
 SCSI interface, 1-6
 supported internal mass storage devices, 1-7
 supported monitors, 1-3

A

archiving, 5-2, 6-15
 automatic system selection, A-6

B

backing up, 5-2-12
 DDS tape, 5-2
 flexible disk, 6-15
 importance of, 7-14
 restoring data, 5-7
 backups, 7-18
 restoring data, 5-8
 Basic documents, 2-3

/bin/ksh, 4-4
 /bin/posix/sh, 4-4
 /bin/sh, 4-4
 booting
 entering information, 3-2
 booting from LAN, 7-11
 boot problems, 7-10
 boot program, 7-10
 Boot ROM
 configuration menu, A-5
 configuration menu , A-6
 configuring, A-2, A-4
 error messages, 7-2
 information, 2-3
 interface defaults, A-4
 startup information, 3-2
 Bourne Shell, 4-3, 4-5
 bus IDs
 determining active SCSI, 6-7

C

cables, 7-16
 CD ROM
 as system backup, 5-2
 installing, 6-18-23
 mounting, 6-21
 SCSI bus address, 6-18
 testing installation, 6-21
 Centronics port, 1-6
 changing a password, 3-7
 changing your shell, 4-5
 chsh, 4-5

Index

- command line
 - logging in, 3-3
 - new user account, 3-5
 - prompt, 4-2
 - setting password, 3-3
 - shutting down, 3-11
 - using, 3-3, 4-1
 - commands
 - chsh**, 4-5
 - cp**, 4-9
 - diskinfo**, 6-14
 - echo**, 4-4
 - exit**, 3-10, 4-5, 4-23
 - fsck**, 7-15, 7-17, 7-18
 - ftp**, 4-17, 4-18, 4-20
 - ioscan**, 6-14
 - lock**, 3-10
 - lp**, 4-12
 - lsf**, 4-8
 - man**, 4-7
 - mkdir**, 4-8
 - mkrs**, 5-2, 5-3, 5-4
 - more**, 4-12
 - mount**, 6-16, 6-17, 6-21
 - mv**, 4-9
 - passwd**, 3-7, 3-8
 - rcp**, 4-17, 4-20, 4-21, 4-22
 - reboot**, 7-17, 7-18
 - reboot**, **-n** option, 7-17, 7-18
 - rlogin**, 4-17, 4-23
 - rm**, 4-10
 - rm -rf** *dirname*, 4-11
 - shutdown**, 3-11
 - umount**, 6-17, 6-22
 - whoami**, 4-2
 - configuration
 - Boot ROM, A-4
 - configuring
 - Boot ROM, A-2
 - Boot ROM menu, A-3
 - CD ROM, 6-18-23
 - DDS drive, 6-24-27
 - flexible disk drive, 6-12
 - hard disk drive jumpers, 6-8
 - HP-UX for a hard disk drive, 6-8
 - printer for HP-UX, 6-3
 - connectors, 1-3
 - Context Dependent Files
 - /hp-ux**, 7-12
 - controller
 - installation documents, 2-2
 - operating tasks, 2-4
 - copy
 - remotely, 4-18, 4-19, 4-21, 4-22
 - core dumps, 7-18
 - correcting typing mistakes with
 - (Back space)**, 4-2
 - cp**, 4-9
 - crash recovery
 - boot from recovery tape, 5-10
 - creating a recovery system, 5-2
 - creating directories with **mkdir**, 4-8
 - C shell, 4-3
- ## D
- data
 - protecting, 5-2
 - restoring individual files, 5-7
 - DDS drive
 - configuring, 6-24-27
 - LEDs, 6-28
 - DDS tape
 - cautions, 6-30
 - maximum usage, 6-30
 - recovery systems, 5-2
 - definitions, terms, Glossary-1-15
 - deleting a file with **rm**, 4-10
 - determining active bus IDs, 6-7
 - device address, 7-12
 - diagnostic indicators, 7-5
 - directories
 - creating sub-directories, 4-8

Index-2

- listing with **lsf**, 4-8
- moving and copying files with **mv** and **cp**, 4-9
- disc caddies, 6-19
- disk drive (CD ROM)
 - installation, 6-18-23
- disk drive (flexible)
 - installation, 6-12-17
- disk drive (hard)
 - installation, 6-8-11
- diskinfo**, 6-11, 6-14, 6-21
- disk storage, 1-7
- DISPLAY** environment variable, 4-24
- displaying windows remotely, 4-24
- drives
 - installing, 6-8-30

E

- echo**, 4-4
- editing a file
 - information, 2-4
 - procedure, 4-14
- editing functions, 4-14
- ejecting a flexible disk, 6-17
- environment variable
 - DISPLAY**, 4-24
- environment variables
 - SHELL**, 4-4
- error messages
 - boot, 7-2
- errors
 - boot problems, 7-10
 - LED indications, 7-5
- etc/checklist**, editing, 6-16, 6-21
- /etc/clusterconf**, 7-11
- /etc/hosts**, 4-18, 4-20
- exit**, 4-5
- exit** command, 3-10
- exiting for an extended period, 3-10
- exiting temporarily (command line), 3-10

F

- Fail-safe Session**
 - HP VUE, 7-8
- files
 - copying between directories, 4-9
 - core**, 7-18
 - /etc/clusterconf**, 7-12
 - moving between directories, 4-9
 - printing, 4-12
 - removing with **rm**, 4-10
 - viewing contents of, 4-12
- files and directories, 4-8
- file system
 - backing up, 5-4
 - restoring, 5-10
 - system panic, 7-17
- file system archiving, 5-2
- flexible disk
 - backing up files, 6-15
 - inserting, 6-17
 - mounting, 6-16
 - removing, 6-17
 - retrieving files, 6-15
 - testing installation, 6-14
- flexible disk drive, 6-12-17
 - installing, 6-12
- floppy (flexible) disk drive, 6-12
- fsck**, 7-15
- ftp**, 4-17, 4-18
 - file manipulation, 4-20

G

- getty** , 3-11

H

- hard disk
 - installing, 6-8
 - testing installation, 6-11
- hard disk drive
 - configuration, 6-8

Index

hardware
 failure at boot, 7-10, 7-16
 failure of peripheral, 7-16
hardware address, 7-11
`$HOME/.rhosts`, 4-20
HP-UX
 command line, 4-2-24
 using, 4-2-24
HP VUE
 activating, 3-12, 3-13
 checking error logs, 7-7
 problems, 7-7
 using, 3-12

I

indicators, 7-4
information, finding, 2-2-4
inserting a CD ROM, 6-19, 6-22
inserting a flexible disk, 6-17
installation
 manuals, 2-2
installation manuals, 2-3
 HP BASIC, 2-3
 HP-UX, 2-3
installing
 CD ROM, 6-18-23
 DDS drive, 6-24-27
 flexible disk drive, 6-12-17
 hard disk drive, 6-8
 preparing for, 6-2
installing a flexible disk drive, 6-12
interfaces
 built in, 1-6
 HP-HIL, 1-6
 LAN, 1-6
 RS-232, 1-6
`ioscan`, 6-14

J

jumper connections
 hard disk (factory), 6-8

Index-4

K

kernel selection, 7-11
keyboard
 installation documents, 2-2
Key Shell, 4-3, 4-6
Korn Shell, 4-3, 4-5

L

LAN
 problems with, 7-17
 system panic, 7-17
LED indicators, 7-4
 diagnostic, 7-5
logging in
 command line, 3-3
 HP VUE, help, 3-14
 problems, 7-8
 when all else fails, 7-8
 without windows, 7-8
logging out of a remote system, 4-23
log in on a remote system
 `rlogin`, 4-23
login shell, 4-5
looking at a file's contents with `more`,
 4-12
`lp`, 4-12
`lsf`, 4-8

M

`man`, 4-7
manipulate files remotely
 `ftp`, 4-20
man pages, 4-7
manuals
 for specific languages, 2-3
 for specific tasks, 2-2, 2-3
 specific tasks, 2-4
`mkdir`, 4-8
`mkrs`, 5-2, 5-3, 5-4
 device files, 5-4

- errors, 5-4
- monitor
 - installation documents, 2-2
- more**, 4-12
- mount**, 6-16, 6-17, 6-21, 6-22
- mounting a CD ROM, 6-21, 6-22
- mounting a disk, 6-17
- mounting a flexible disk, 6-16
- mouse
 - installation documents, 2-2
- mv**, 4-9

N

- network
 - installation documents, 2-2
 - Internet Protocol, entering, 2-4
 - operation, 2-4
- network copying
 - ftp**, 4-18
- network IP number
 - documents for entering, 2-3
- network problems, 7-20
- new user account, 3-5
- NFS file system
 - recovery using SAM, 5-7
- No Windows VUE** option, 3-11

O

- operating systems, supported, 1-8
- operating tasks
 - documents, 2-4
- Options** menu, 7-8

P

- panic message, 7-16
- panic.system, 7-14
- Pascal documents, 2-3
- passwd** command, 3-7
- password
 - selecting, 3-7
- peripherals

- disk drive, 6-9
- ports
 - AUI LAN, 1-6
 - HP Parallel, 1-6
 - IEEE, 1-6
 - LAN, 1-6
 - ThinLAN, 1-6
- Posix Shell, 4-3
- powering down, 3-11
- pre-installed systems, 3-2
- preparing for installation, 6-2
- printer
 - installing using SAM, 6-3
 - testing installation, 6-5
 - troubleshooting, 6-6
- printing a file
 - lp**, 4-12
- problems
 - booting from LAN, 7-11
 - can't find kernel, 7-12
 - network, 7-20
 - printer, 6-6
 - secondary loader, 7-11
 - system boot, 7-10, 7-17
 - with hardware, 7-16
- product description, 1-1
- prompt, command line, 4-2

R

- rbootd** daemon, 7-12
- rnp**, 4-17, 4-20, 4-21, 4-22
- recovery systems, 5-2
- remotely copying a directory, 4-20
- remotely copying a file, 4-20
- removing
 - CD ROM, 6-22
 - directory and contents, 4-11
 - flexible disk, 6-17
- removing a file with **rm**, 4-10
- restoring, 5-2
- restoring file system, 5-10-12

Index

restoring individual files, 5-7-9
restoring operating system, 5-10-12
restricted shells, 4-4
retrieving files, 6-15
`.rhosts`, 4-20, 4-21, 4-23
`rlogin`, 4-17, 4-23
`rm`, 4-10, 4-11
`rm -rf`, 4-11
running commands, 4-2

S

SAM

backing up with, 5-2, 5-4
new user account, 3-5

SCSI bus address

finding existing, 6-7

SCSI bus IDs

determining active, 6-7

`scsi` device file, 6-8

secondary loader problems, 7-11

secondary loader program, 7-10, 7-11

`set_parms` , 3-2

setting a password, 3-7

SHELL environment variable, 4-4

shells, 4-3

changing your shell, 4-5
default prompt, 4-4
documents for using, 2-4
features compared, 4-4
file names, 4-4

Shells: User's Guide, 4-7

starting a system, 3-2

starting HP VUE, 3-12

system

operating tasks, 2-4
system information , 3-2
system panic
core dumps, 7-18
hardware failure, 7-16
LAN, 7-17
recovering from, 7-14

system recovery, 5-10
system security, 3-7, 3-8

T

`telinit` , 3-11

terms, definitions, Glossary-1-15

testing installation

CD ROM, 6-21

testing installation (flexible disk), 6-14

testing installation (hard disk), 6-11

troubleshooting

system panic, 7-14-19

typing commands, 4-2

U

`umount` , 6-17

unmounting a CD ROM, 6-22

unmounting a disk, 6-17

unused SCSI bus address

finding , 6-7

user account, 3-5

user name, 4-5

using DDS drive, 6-28

V

`vi`, 4-14-16

basic editing functions, 4-14

cursor movement, 4-15

documents, 4-16

quitting, 4-15

saving documents, 4-15

viewing a file

information, 2-4

viewing a file with `more`, 4-12

VUE (HP VUE)

activating, 3-12, 3-13

W

`whoami`, 4-2

Index-6



X

xterm window, 3-12

X Window System

activating, 3-12

information, 2-4

